

Joining Metals with Stamping Dies

A Die Builder's Guide to BTM Corporation's sheet metal clinch joining systems.



A supplement for BTM Corporation's Tog-L-Loc® and Lance-N-Loc™ Tooling Catalogs to assist in the proper application of tooling within a stamping die.

BTM
CORPORATION



www.BTMcorp.com

810-364-4567

BTM Die Set Clinch Tooling

BTM offers a range of standard tooling which can be utilized in a die set. Catalogs detailing BTM's standard Tog-L-Loc® and Lance-N-Loc™ tooling are available at our website: www.BTMcorp.com or by request. For information on non-standard tooling, please contact BTM Corporation's Special Products Division.



TOG-L-LOC® DIE COMPARISON

STANDARD DIES	OTHER DIES - Contact BTM for more info.	
<p>940 Series Dies</p>  <p>940 Dies feature a built in die shield that surrounds an elastomer ring [or a canted coil spring] and three die blades.</p>	<p>Three Bladed Elastomer Dies</p>  <p>These dies are ideal when the die guarding can be modified to incorporate contour features in a part.</p>	<p>Two Bladed Dies</p>  <p>Ideal for very tight joining locations up against a flange, where the blades can operate parallel.</p>

LANCE-N-LOC™ DIE COMPARISON

<p>940 Series Dies</p>  <p>940 Dies feature a built in die shield that surrounds an elastomer ring [or a canted coil spring] and three die blades.</p>	<p>Two Bladed Elastomer Dies</p>  <p>These dies are ideal when the die guarding can be modified to incorporate contour features in a part.</p>	<p>Two Bladed Dies</p>  <p>Ideal for very tight joining locations up against a flange, where the blades can operate parallel.</p>
---	---	--

PUNCH COMPARISON

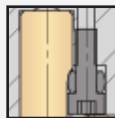
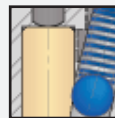
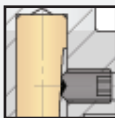
Tog-L-Loc®	Lance-N-Loc™	Punch Retention		
		<p>940*</p> 	<p>Ball Lock</p> 	<p>WNF*</p> 

STANDARD DIE HOLDERS

Style "A" Holder
For Style "A" Dies



Round Holder*

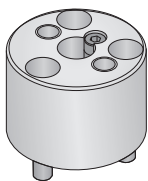

THIN Holder*

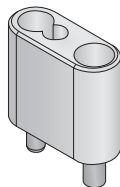

STANDARD PUNCH HOLDERS

THIN Holder*

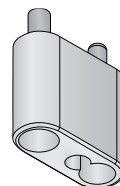

Round Holder

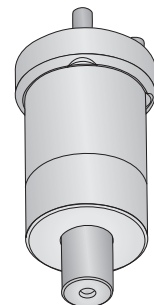

*Tog-L-Loc only

EXAMPLES OF VARIOUS TOG-L-LOC TOOL SET-UPS IN A DIE

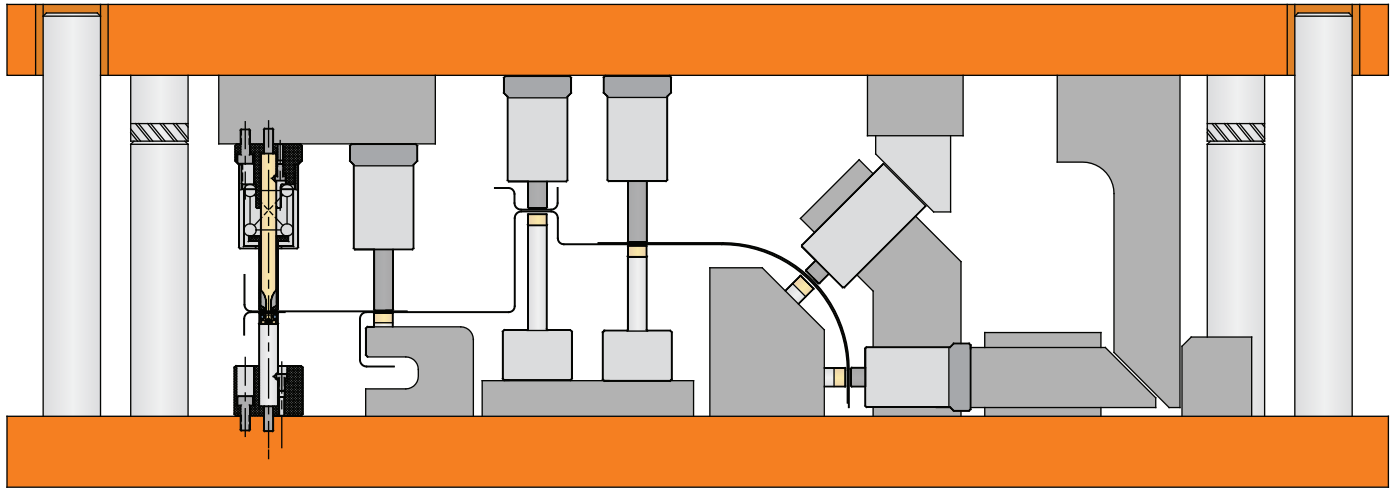

EXAMPLES OF VARIOUS DIE SETS BUILT BY BTM

BTM can either build a custom die set for you, or supply the tooling for you to make your own. Shown below are a few examples of die sets that BTM has built.

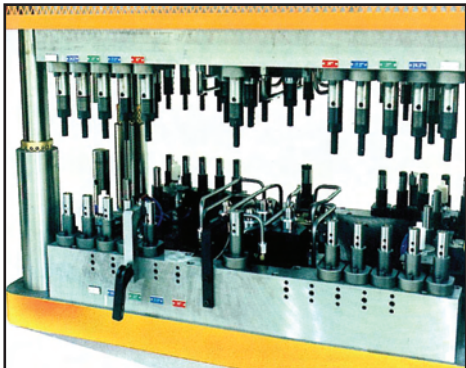

Tog-L-Loc die for joining prepainted steel furnace panel.

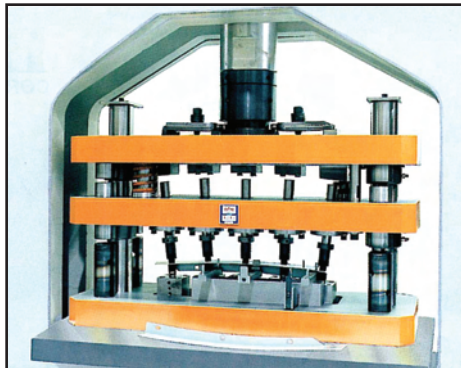

Tog-L-Loc "bump" die for curved automotive component.

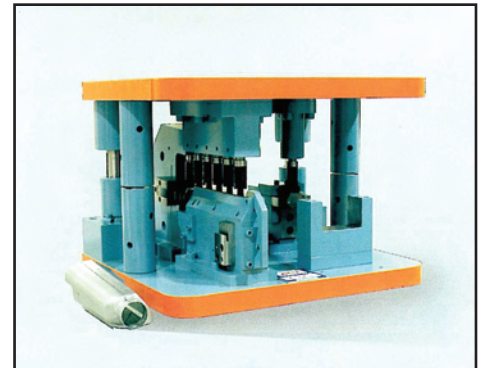

Tog-L-Loc die for joining aluminized steel heat stove.

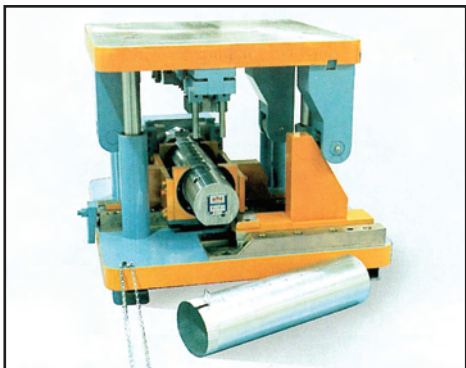

Tog-L-Loc die for joining dryer vent tube.

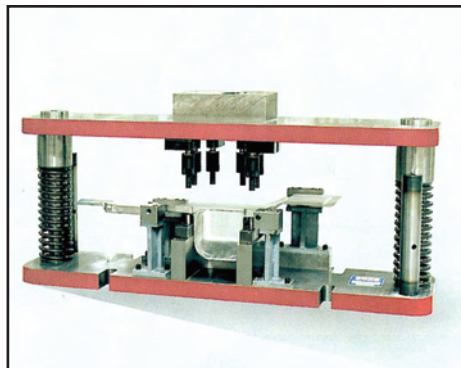

Tog-L-Loc die for joining aluminum automotive component.



Tog-L-Loc "bump" die for joining prepainted aluminum sunroof.

CHOOSING THE CORRECT TOOLING/JOINT SIZE

Joint strength increases with joint size. Force required to produce the joint also increases, as does the physical size of the tooling. Choosing the correct joint size for a given application involves determining the strength required of each joint, and accessibility of the joining site. Contact a BTM Applications Engineer to determine the correct tooling for your application.

ALIGNMENT

The Tog-L-Loc or Lance-N-Loc tooling must be aligned both concentric and square. Misalignment can cause tool damage and reduced joint strength. The joints must be formed perpendicular to the metal surfaces. All of the Tog-L-Loc tool sets within the die must be set up to bottom simultaneously in order to produce consistent button dimensions for all of the joints.

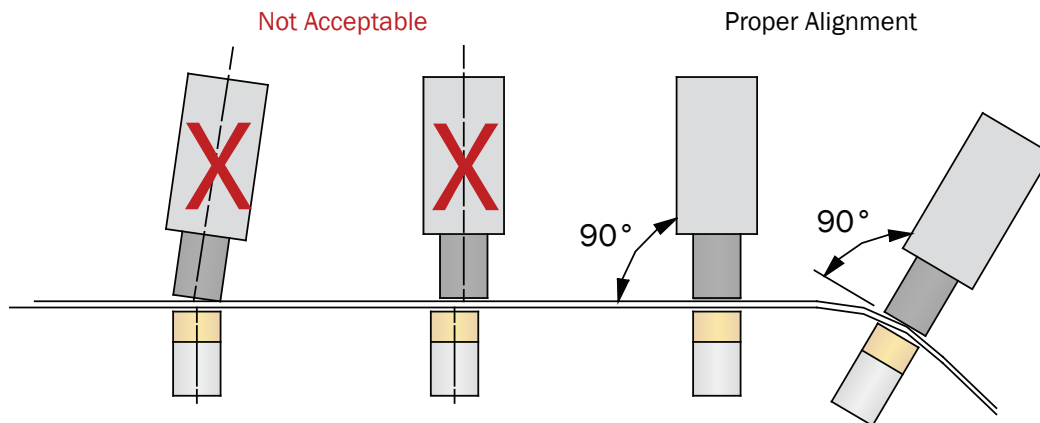

PARTS

Parts should mate flat and evenly at the joining site; however, the stripper pressure will draw slightly deformed parts together. Parts should be located by nesting and/or pins.

STRIPPERS

A spring pressure pad/stripper must surround the Tog-L-Loc punches. Standard BTM strippers should be used, or specially made strippers providing sufficient force as indicated in the chart:

Required Stripper Spring Pressure Upon Punch Contact with Material					
3.0	3.8	4.6	5.5	6.4	7.6
0.89kN [200 lbs.]	1.1 kN [250 lbs.]	1.3 kN [300 lbs.]	2.3kN [525 lbs.]	3.3kN [750 lbs.]	4.4kN [1000 lbs.]

UNLOADING

The design of the nesting must allow the joint “buttons” to be lifted out of the Tog-L-Loc dies for unloading. Parts can be lifted from the dies on a 45° angle due to the patented tool design. No significant force is required to remove buttons from the dies.

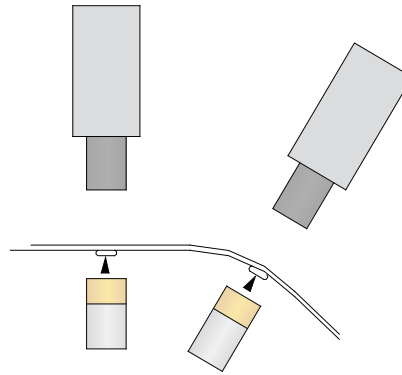

Joint Buttons must be lifted out of the Dies

RIGIDITY

Die shoes, tool holders, and all components of the die must work to prevent deflection to ensure joint quality and tool life.

STOP BLOCKS

Ground stop blocks must be used to bring the Tog-L-Loc tooling to a mechanical stop. This allows control of the “BD” (button dimension) for quality control.

BALANCE

The stop blocks must be positioned to balance the forces over the Tog-L-Loc pattern in order to produce consistent button dimensions and ensure tool longevity.

OFF-AXIS JOINING

Cam or “bump” dies must be constructed adequately to maintain alignment and prevent deflection of the Tog-L-Loc tooling.

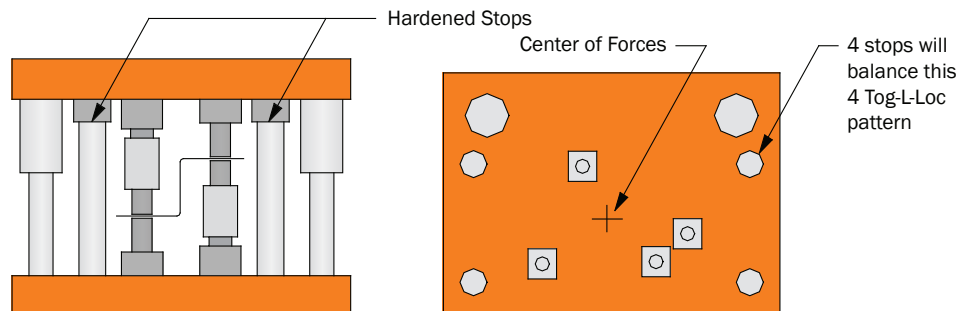

SETUP & TRYOUT

1. When the die is installed, a means of adjustment should be provided between the press ram and the upper shoe.
 2. On initial tryout, the upper shoe should be backed off from the work position to avoid damaging the Tog-L-Loc tools. Set the die to allow clearance between punch tip and die anvil equal to the combined thickness of the sheet metals.
 3. A series of press cycles and die shoe (shut height) adjustments are then made until the correct "BD" is achieved. If multiple Tog-L-Loc tool sets are used, it may be necessary to adjust individual tools for consistent BD by shimming and/or grinding riser blocks to which the tools are mounted.
 4. The stop blocks are then ground to stop the die at the height which produces the specified button dimension ("BD").
-

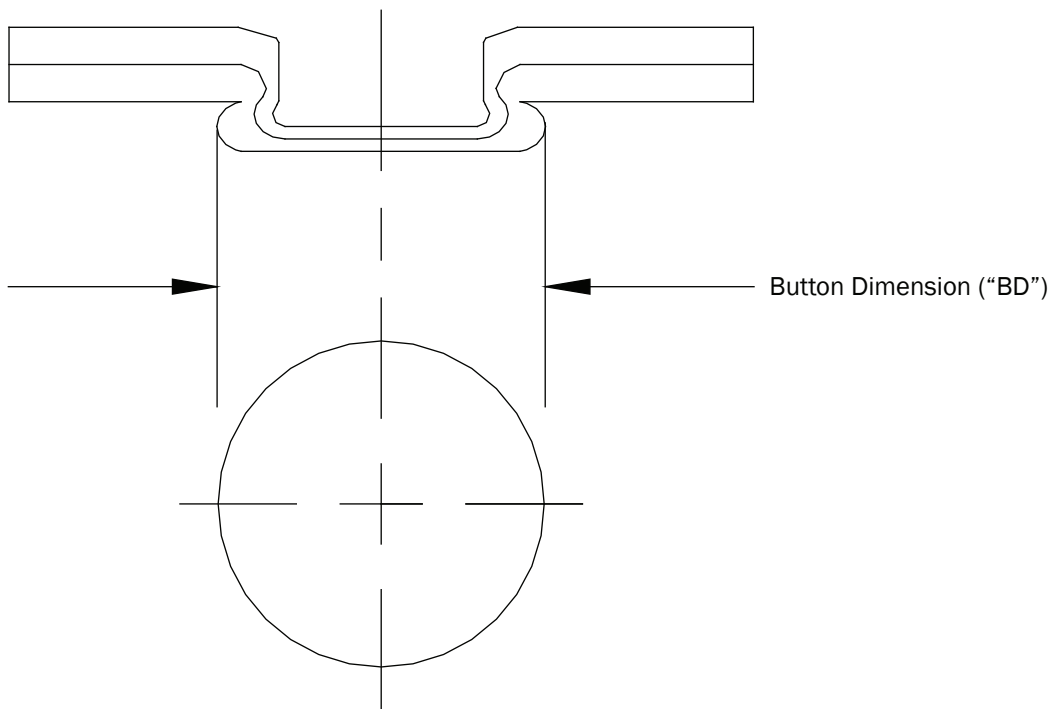

OPERATION

The “BD” or button dimension is the key to simplified quality control in a Tog-L-Loc system. BTM provides a specified BD for each given metal combination. A tolerance of $+0,25 / -0,0$ ($+0.010 - .000$) is generally allowed on the BD to allow for standard mill tolerance in sheet metal thickness. On installation, the stop blocks are ground to produce the correct BD.

The Tog-L-Loc tools are hardened, and will generally not require adjustment due to wear. If the BD falls out of tolerance, use the following checklist:

1. Verify that the metals being joined are the same as the die was set up for. A change in thickness or alloy may require adjustment or a different punch and/or die.
2. Replace any weak or damaged stripper springs. A spring which is broken or compressed in height can cause the BD to change.
3. Inspect the Tog-L-Loc tools for chipped surfaces, broken die blades or springs, and compressed height. Replace any tools which are damaged.
4. Inspect the die shoes, blocks, adjustments, press components for damage which could result in deflection.
5. Verify that the press is producing adequate force.

Refer to the BTM Tog-L-Loc User’s Guide for additional process information. (available at BTM’s website, or by request.)

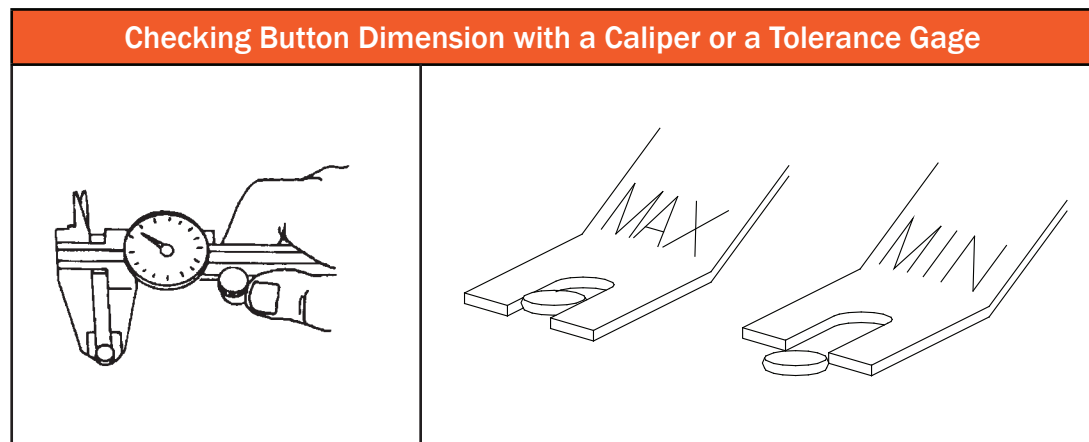

BTM[®] CORPORATION

BTM has a wide range of products for applying Tog-L-Loc[®] tooling including:

Press Brakes



BTM's unitized press brake tooling is a low cost way to utilize the patented Tog-L-Loc[®] sheet metal joining system and is available with a wide range of throat depths. The units are set up for a specified metal combination, and are ready to install into your brake.

Die Sets



Tog-L-Loc[®] tooling can be inexpensively designed into single or compound motion die set packages.

Handheld Units



BTM's handheld units are an economical approach to fastening sheet metal assemblies. Pneumatic, Hydraulic, and Self-Contained Units in a variety of styles are available. The units can be set up to join a range of thicknesses or optimized for a specific metal thickness.

Special Fixtures



Manually loaded and unloaded dedicated tooling can be built for a single part or a family of parts.

Universal Presses



Universal presses are hydraulically operated presses that easily adapt to join a variety of parts.

Special Systems



Achieve faster cycle times with automatic parts handling and/or by combining processes.

Specialized Units



BTM provides pneumatic, hydraulic, air/oil, and electrically driven units with single or dual motions for both stationary and robotic applications.

For more information, or to see our full line of products, please visit:

www.BTMcorp.com