

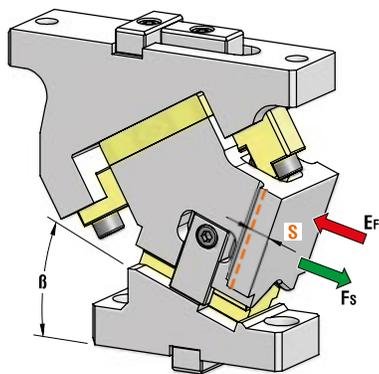

**AERIAL CAM UNIT - OBEN HÄNGENDER SCHIEBER - UNITÀ A CAMME SOSPESA**



P.605

OMCR CODE	Work Angle $\beta$	Stroke (mm) <b>S</b>	Max Work Force with shoulder (kN) <b>F<sub>s</sub></b>	Extraction Force (kN) <b>E<sub>f</sub></b>	
				Spring	Gas Spring
CHD065.00	0°	14,98	60	1,31	1,72
CHD065.05	5°	15,62	60	1,30	1,67
CHD065.10	10°	15,64	60	1,14	1,60
CHD065.15	15°	16,96	60	1,14	1,60
CHD065.20	20°	18,43	60	1,14	1,60
CHD065.25	25°	18	60	1,29	1,53
CHD065.30	30°	17,36	60	1,17	1,47
CHD065.35	35°	18,87	60	1,17	1,47
CHD065.40	40°	20,57	60	1,17	1,47
CHD065.45	45°	22,54	60	1,17	1,47
CHD065.50	50°	23,34	60	1,17	1,44
CHD065.55	55°	26,05	60	1,17	1,44
CHD065.60	60°	31,51	60	1,17	1,47
CHD065.65	65°	36,57	60	1,17	1,47

**OPTION CODE**

SL	1 ÷ 60 (1mm steps)
----	--------------------

\*Return Type: G = Gas Spring / S = Spring

		OPTION CODE		
STOCK	ORDER EXAMPLE	Art.	Work Angle = 5°	Return Type*
		CHD065	05	G
				SL
				SL55

OMCR CODE	Work Angle $\beta$	Overall Dimensions (mm)			
		A	B	C	D
CHD065.00	0°	185	67,50	80	205
CHD065.05	5°	188,04	68,29	75	200
CHD065.10	10°	185,99	69,77	65	190
CHD065.15	15°	188,77	71,95	65	190
CHD065.20	20°	186,34	74,79	55	180
CHD065.25	25°	181,62	80,28	41	166
CHD065.30	30°	180,58	85,39	40	165
CHD065.35	35°	177,15	90,10	25	150
CHD065.40	40°	173,29	95,35	22,5	147,5
CHD065.45	45°	169,94	98,13	10	135
CHD065.50	50°	164,07	99,37	5	130
CHD065.55	55°	158,64	111,04	-15	110
CHD065.60	60°	152,61	118,08	-25	100
CHD065.65	65°	145,95	125,44	-35	90



AERIAL CAM UNIT - OBEN HÄNGENDER SCHIEBER - UNITÀ A CAMME SOSPESA

X VIEW

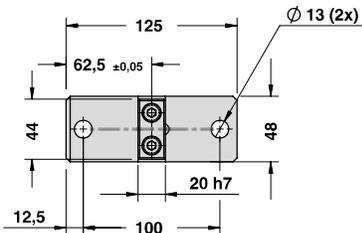
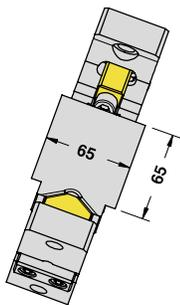

CAM DIAGRAM

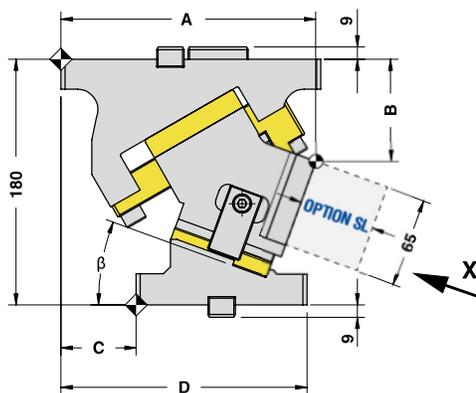
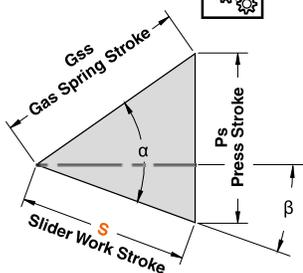

Cam Units CHD

Work Angle	Inner Angle	Slider Work Stroke (mm)	Press Stroke (mm)	Gas Spring Stroke (mm)
$\beta$	$\alpha$	S	Ps	Gss
0°	50°	14,98	17,85	23,3
5°	50°	15,62	16,92	22
10°	50°	15,64	15,64	20,1
15°	50°	16,96	15,86	20
20°	50°	18,43	16,30	20
25°	50°	18,00	15,21	18
30°	50°	17,36	14,15	16
35°	50°	18,87	14,96	16
40°	50°	20,57	16,00	16
45°	50°	22,54	17,33	16
50°	50°	23,34	17,88	15
55°	50°	26,05	20,03	15
60°	50°	31,51	24,51	16
65°	50°	36,57	29,00	16

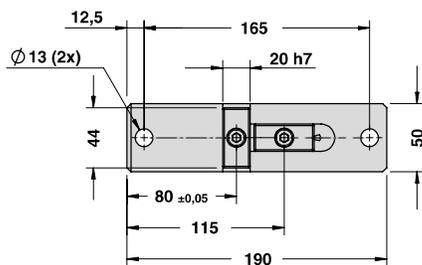



AERIAL CAM UNIT - OBEN HÄNGENDER SCHIEBER - UNITÀ A CAMME SOSPESA

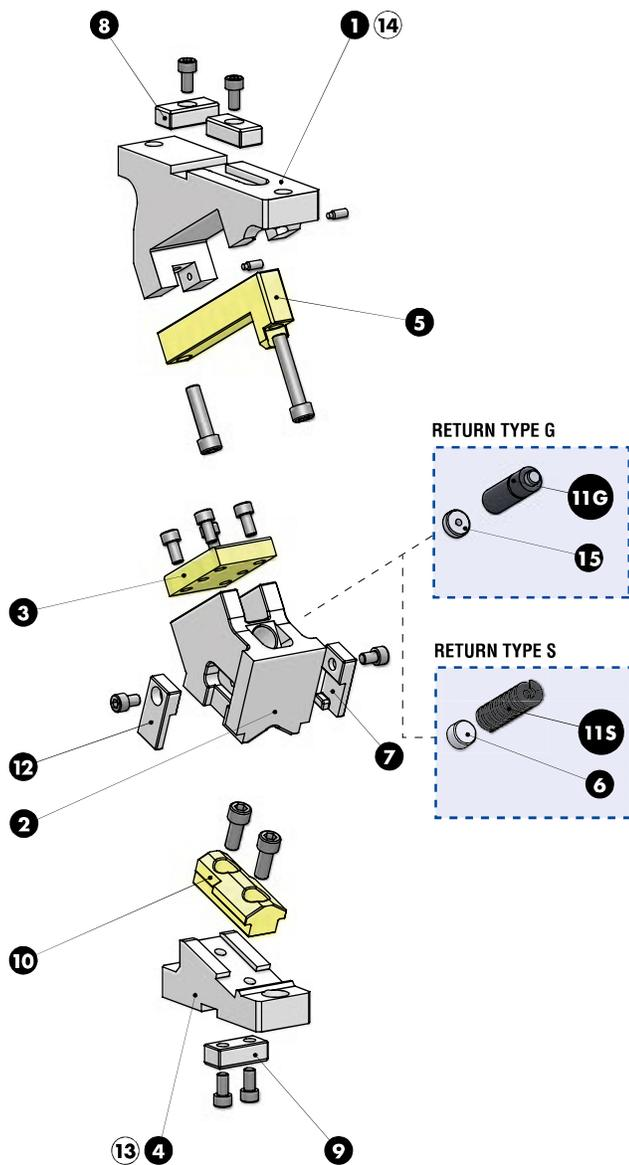



**AERIAL CAM UNIT - OBEN HÄNGENDER SCHIEBER - UNITÀ A CAMME SOSPESA**

**SLIDER STRUCTURE, POSITIVE RETURN STRUCTURE AND CLEARANCES**

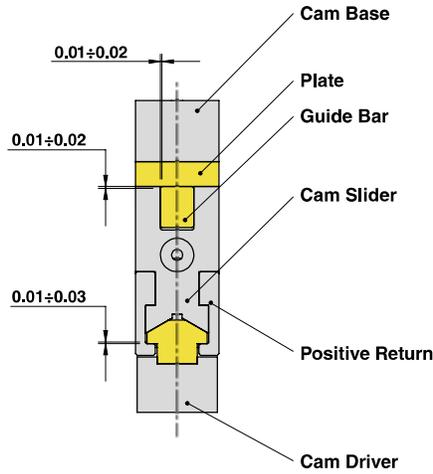

Cam Units CHD

**PART LIST**

Particular number	Description	Material	Quantity
1	Cam Base	CK45	1
2	Cam Slider	GG-30	1
3	Plate	CuZn25Al5 + Graphite - HB > 190	1
4	Cam Driver	CK45	1
5	Guide Bar	CuZn25Al5 + Graphite - HB > 190	1
6	Spring Spacer	CK45	1
7	Positive Return R	42CrMo4 Nitrided	1
8	Key	CK45	2
9	Key	CK45	1
10	Male "V" Driver	CuZn25Al5 + Graphite - HB > 190	1
11G	Gas Spring - <b>Return Type G</b>	-	1
11S	Spring - <b>Return Type S</b>	-	1
12	Positive Return L	42CrMo4 Nitrided	1
13	Cam Driver Fixing Screws M12x35 DIN 912	-	2
14	Cam Base Fixing Screws M12x45 DIN 912	-	2
15	Gas Spring Spacer	CK45	1

