

Gas springs, Dampers and Adjustment systems

[Product catalog](#)

Contents

Mechanical Systems	5
Gas Spring Liftline	6
Design and functionality	8
Standard program	9
Fittings	14
Special functions	18
Lockable Gas Spring Lockline	20
Design and functionality	22
Standard program	23
Special functions	26
Hydraulic Damper Softline	28
Design and functionality	30
Standard program	31
Variations	32
Piston Rod and Tube	36

Height Adjustment	40
Office	42
Electric Height Adjustment	44
Columns ELS3	44
Table subframe VariFrame	46
Table subframe FixFrame	47
ELS3 Duo workplace	48
Accessories and switches	49
Pneumatic Height Adjustment	50
Table column VariBase	50
Table column VariStand	51
Industry	52
Electric Height Adjustment	54
Actuator Movotec SMS	54
Column ELS3 HeavyDuty	55
Accessories and switches	56
Hydraulic Height Adjustment Movotec	58



Mechanical Systems

Industry

Office

Piston rods + Tubes

Dampers

Lockable Gas springs

Gas springs

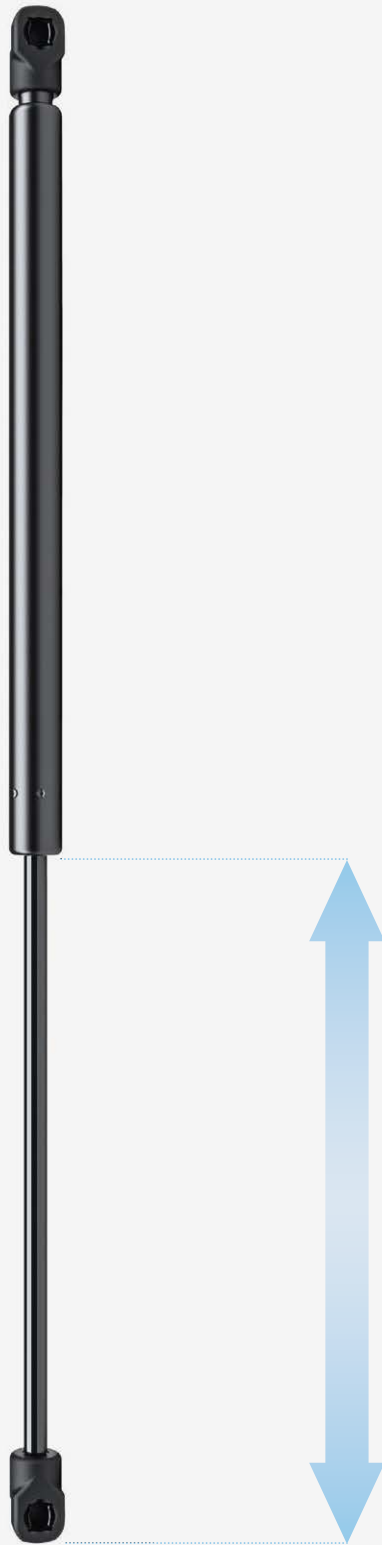

Gas spring Liftline (standard program)

Liftline is an excellent gas spring program offered by SUSPA. Successfully proven in the market for decades and always state-of-the-art through constant innovation.

The SUSPA Liftline program includes five basic types: the types 16-12, 16-1, 16-2, 16-4 and 16-6.

The main differences are in the tube and piston rod diameters and the different extension forces. This way, we can meet your specific technical requirements with the optimal gas spring type.

Type	Ø Tube (mm)	Ø Piston rod (mm)	Stroke max. (mm)	Extension force F_1 (N)
16-12*	12	4	150	40 - 180
16-1*	15	6	150	50 - 420
16-2*	18.5	8	250	80 - 750
16-3	22	8	495	100 - 1,200
16-4*	22	10	495	100 - 1,200
16-6*	28	14	500	200 - 2,000

* Standard program, pages 9-13



Configure your individual gas strut at
www.suspa.com/global/configurator

Applications



Tailgate



Steering columns

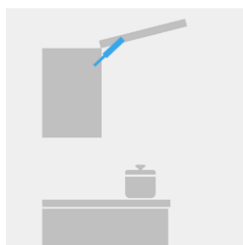

Kitchen cabinet

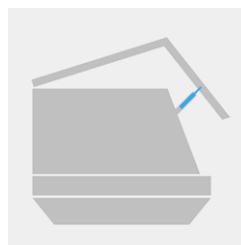

Machinery lids

Gas spring Liftline

Design and functionality

How force and effective cushioning are produced

Gas springs are hydropneumatic adjustment elements. They consist of a pressure tube plus piston rod with piston unit. Connecting elements on the pressure tube and the piston rod allow appropriate connection to your application.

At the core of the SUSPA gas spring is the special seal and guide system. This ensures hermetic sealing of the cavity with low friction, even under extreme environmental conditions.

The gas spring is filled with non-toxic nitrogen at high pressures. This produces a charging pressure that in turn exerts an effect on the cross section of the piston rod, generating the extension force. If the extension force of the gas spring is greater than the force of the counterbalance, the piston rod extends; if the extension force is smaller, it retracts. The speed of the extension is determined by the flow cross section in the damping system.

In addition to nitrogen, the cavity contains a defined quantity of oil for lubrication and end position cushioning. The cushioning effect of a gas spring can be determined depending on the requirements and the task involved.

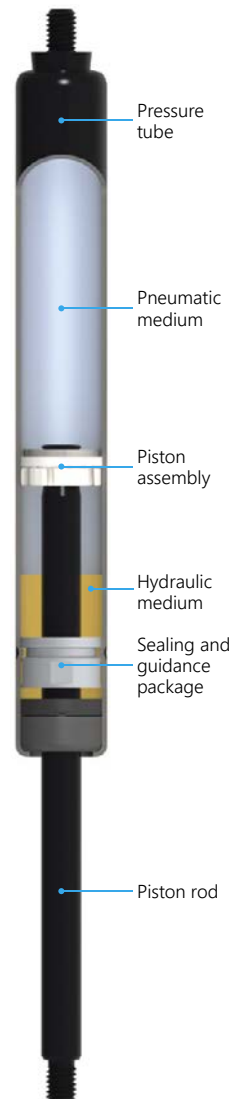

Spring characteristic

As seen in the graphic, the spring characteristic curve shows the force path of the gas spring over the stroke, from the extended to the retracted state and back. The spring characteristic illustrates the balance of power of F_2/F_1 . For the design of gas springs, the force F_1 is, in addition to the dimensions, the most important criterion.

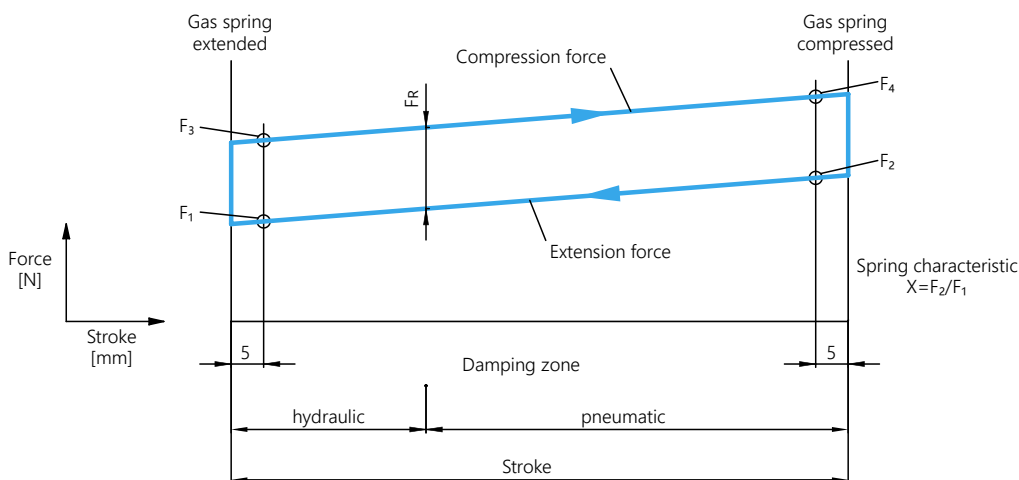

Gas spring Liftline Type 16-12 (standard program)

Ø tube 12 mm, Ø piston rod 4 mm, max. stroke 150 mm, extension force 40-180 N

Type 16-12 Thread/Thread

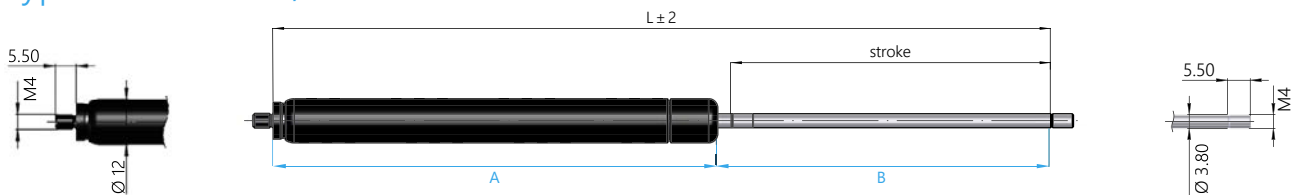

Fitting AM4

All dimensions in mm, The standard color of the tube is black or white aluminum, and the piston rod is black.

Fitting BM4

Select length, stroke and extension force

Length L (mm) ±2	Stroke (mm)	Technical data	Extension force F_1
72	20	16-12 - 49 - 23 - AM4 - BM4 -	Select the desired extension force F_1 : $40\text{ N} \leq F_1 \leq 180\text{ N}$ * The maximum F_1 extension force depends on the customer's application. Please contact us for your individual layout.
92	30	16-12 - 59 - 33 - AM4 - BM4 -	
112	40	16-12 - 69 - 43 - AM4 - BM4 -	
132	50	16-12 - 79 - 53 - AM4 - BM4 -	
152	60	16-12 - 89 - 63 - AM4 - BM4 -	
192	80	16-12 - 109 - 83 - AM4 - BM4 -	
232	100	16-12 - 129 - 103 - AM4 - BM4 -	
272*	120	16-12 - 149 - 123 - AM4 - BM4 -	
332*	150	16-12 - 179 - 153 - AM4 - BM4 -	

i Order example: **16-12** - **179** - **153** - **A446** - **B446** - **120N**
Type Tube (A) Piston rod (B) Tube (A) Piston rod (B) Extension force F_1
Length (mm) Fitting

i Please select your fittings on page 14

Damping behaviour

Type 16-12 can be used without extension force as a damper. The damping behavior can be chosen according to your needs. The characteristic curve shows the damping force depending on the extension speed.

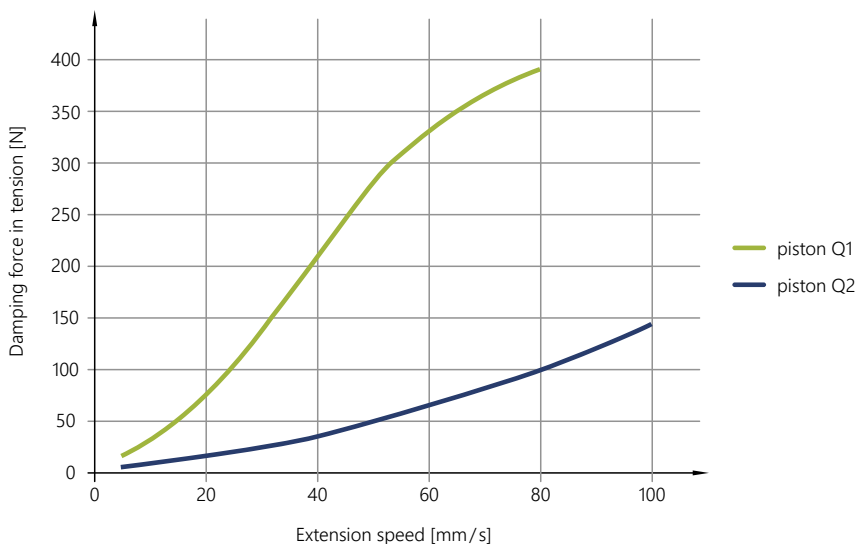

Gas spring Liftline Typ 16-1 (standard program)

Ø tube 15 mm, Ø piston rod 6 mm, max. stroke 150 mm, extension force 50-420 N

Typ 16-1 Thread/Thread

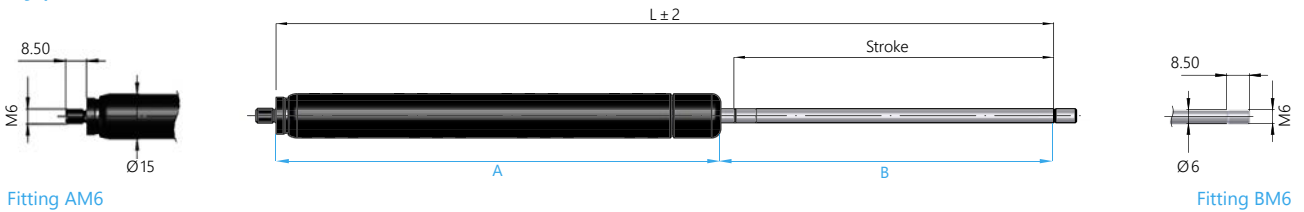

Select length, stroke and extension force

Length L (mm) ±2	Stroke (mm)	Technical data	Extension force F_1
77.5	20	16-1 - 53.5 - 24 - AM6 - BM6 -	Select the desired extension force F_1 : $50 \text{ N} \leq F_1 \leq 420 \text{ N}$ Type 16-1 can be used as a damper without extension force. Please contact us for your individual layout.
107	35	16-1 - 67 - 40 - AM6 - BM6 -	
117.5	40	16-1 - 72.5 - 45 - AM6 - BM6 -	
156.5	60	16-1 - 91 - 66.5 - AM6 - BM6 -	
197	80	16-1 - 113 - 84 - AM6 - BM6 -	
207	85	16-1 - 117 - 90 - AM6 - BM6 -	
235	100	16-1 - 131 - 104 - AM6 - BM6 -	
278	120	16-1 - 154 - 124 - AM6 - BM6 -	
285	120	16-1 - 161 - 124 - AM6 - BM6 -	
316	135	16-1 - 168 - 148 - AM6 - BM6 -	
337.5	150	16-1 - 183.5 - 154 - AM6 - BM6 -	

i Order example: **16-1 - 161 - 124 - A220 - B220 - 120N**
 Type Tube (A) Piston rod (B) Tube (A) Piston rod (B) Extension force F_1
 Length (mm) Fitting

i Please select your fittings on page 15

Typ 16-1 Clevis/Clevis, welded

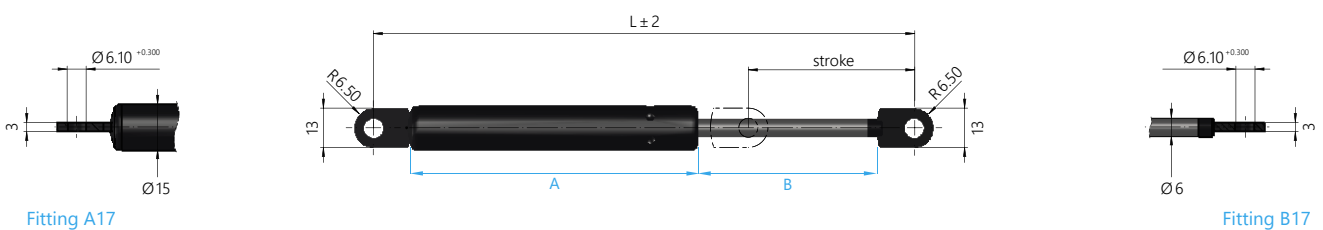

Length L (mm) ±2	Stroke (mm)	Technical Data	Order number
106	20	16-1 - 57 - 26 - A17 - B17	01625007
146	40	16-1 - 78 - 45 - A17 - B17	01625008
160	45	16-1 - 86 - 51 - A17 - B17	01625075
179	55	16-1 - 96 - 60 - A17 - B17	01625076
186	60	16-1 - 96 - 67 - A17 - B17	01625009
224	80	16-1 - 111 - 90 - A17 - B17	01625010
264	100	16-1 - 131 - 110 - A17 - B17	01625011
306	110	16-1 - 168 - 115 - A17 - B17	01625077
305.5	120	16-1 - 157.5 - 125 - A17 - B17	01625012
366	150	16-1 - 189 - 154 - A17 - B17	01625013

All dimensions in mm. The standard color of the tube and the piston rod is black.

Gas spring Liftline Type 16-2 (standard program)

Ø tube 18.5 mm, Ø piston rod 8 mm, max. stroke 250 mm, extension force 80-750 N

Typ 16-2 Thread/Thread

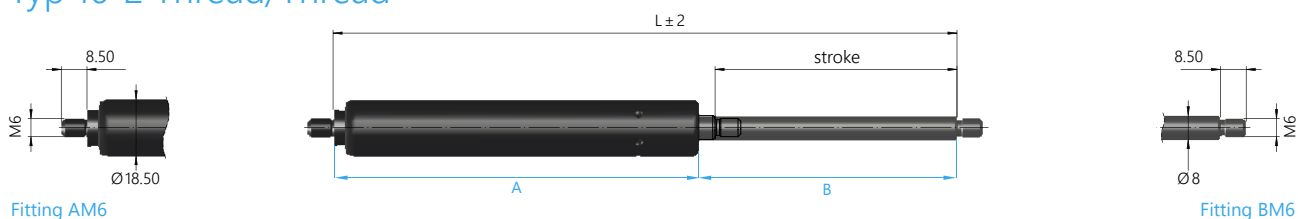

Select length, stroke and extension force

Length L (mm) ±2	Stroke (mm)	Technical data	Extension force F_1
128	40	16-2 - 78 - 50 - AM6 - BM6 -	Select the desired extension force F_1 : $80\text{ N} \leq F_1 \leq 750\text{ N}$ Please contact us for your individual layout.
168	57	16-2 - 109 - 59 - AM6 - BM6 -	
206	80	16-2 - 121 - 85 - AM6 - BM6 -	
218	85	16-2 - 128 - 90 - AM6 - BM6 -	
248	100	16-2 - 138 - 110 - AM6 - BM6 -	
268	105	16-2 - 158 - 110 - AM6 - BM6 -	
288	120	16-2 - 163 - 125 - AM6 - BM6 -	
328	140	16-2 - 178 - 150 - AM6 - BM6 -	
367	160	16-2 - 203 - 164 - AM6 - BM6 -	
408	180	16-2 - 223 - 185 - AM6 - BM6 -	
453	195	16-2 - 253 - 200 - AM6 - BM6 -	
447.5	200	16-2 - 240 - 207.5 - AM6 - BM6 -	
489	220	16-2 - 264 - 225 - AM6 - BM6 -	
547.5	250	16-2 - 294 - 253.5 - AM6 - BM6 -	

i Please select your fittings on page 15

Type 16-2 Clevis/Clevis, welded

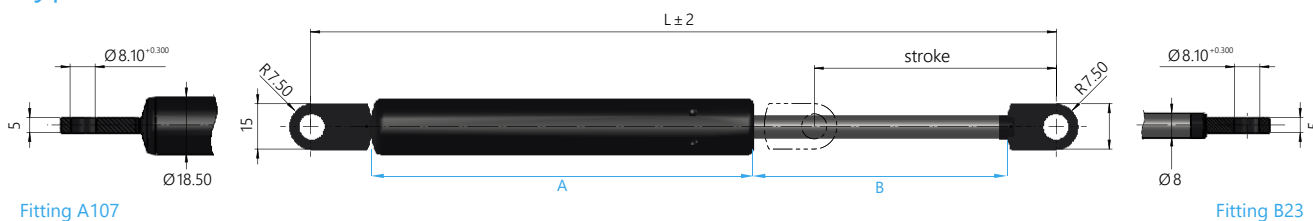

Length L (mm) ±2	Stroke (mm)	Technical data	Order number
206.5	60	16-2 - 108 - 65 - A107 - B23	01625024
246.5	80	16-2 - 128 - 85 - A107 - B23	01625025
256.5	90	16-2 - 128 - 95 - A107 - B23	01625082
286.5	100	16-2 - 143 - 110 - A107 - B23	01625026
316.5	120	16-2 - 158 - 125 - A107 - B23	01625083
326.5	120	16-2 - 168 - 125 - A107 - B23	01625027
354.5	133	16-2 - 183 - 138 - A107 - B23	01625084
364.5	140	16-2 - 186 - 145 - A107 - B23	01625028
407.5	160	16-2 - 201 - 173 - A107 - B23	01625029
444.0	178	16-2 - 229.5 - 181 - A107 - B23	01625030
485.5	200	16-2 - 240 - 212 - A107 - B23	01625031
525.5	220	16-2 - 267 - 225 - A107 - B23	01625032
586.5	250	16-2 - 291 - 262 - A107 - B23	01625033

Gas spring Liftline Type 16-4 (standard program)

Ø tube 22 mm, Ø piston rod 10 mm, max. stroke 495 mm, extension force 100-1.200 N

Typ 16-4 Thread/Thread

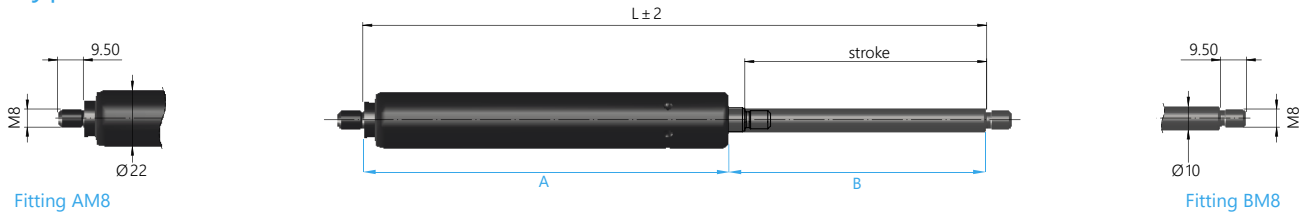

Select length, stroke and extension force

Length L (mm) ±2	Stroke (mm)	Technical data	Extension force F_1
248	98	16-4 - 148 - 100 - AM8 - BM8 -	Select the desired extension force F_1 : $100 \text{ N} \leq F_1 \leq 1.200 \text{ N}$ Please contact us for your individual layout.
288	120	16-4 - 163 - 125 - AM8 - BM8 -	
348	148	16-4 - 198 - 150 - AM8 - BM8 -	
367	150	16-4 - 198 - 170 - AM8 - BM8 -	
406	168	16-4 - 236 - 170 - AM8 - BM8 -	
448	198	16-4 - 248 - 200 - AM8 - BM8 -	
548	248	16-4 - 298 - 250 - AM8 - BM8 -	
648	295	16-4 - 348 - 300 - AM8 - BM8 -	
748	345	16-4 - 398 - 350 - AM8 - BM8 -	
768	345	16-4 - 418 - 350 - AM8 - BM8 -	
848	395	16-4 - 448 - 400 - AM8 - BM8 -	
948	445	16-4 - 498 - 450 - AM8 - BM8 -	
1.048	495	16-4 - 548 - 500 - AM8 - BM8 -	

i Order example: **16-4 - 163 - 125 - A207 - B207 - 500N**

Type Tube (A) Piston rod (B) Tube (A) Piston rod (B) Extension force F_1
└── Length (mm) ──┘ └── Fitting ──┘

i Please select your fittings on page 16/17

Typ 16-4 Clevis/Clevis, welded

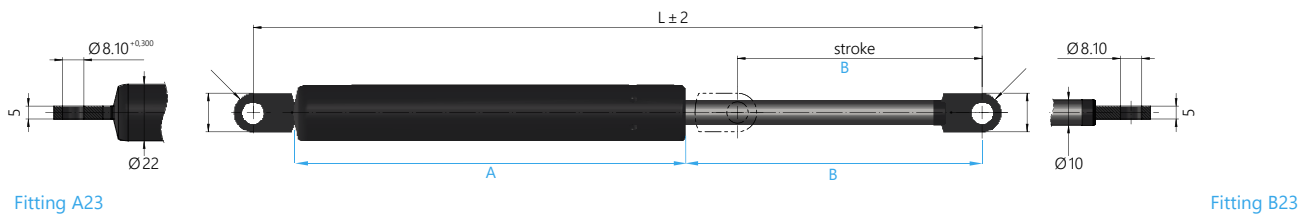

Length L (mm) ±2	Stroke (mm)	Technical data	Order number
283	95	16-4 - 153 - 100 - A23 - B23	01625043
383	145	16-4 - 203 - 150 - A23 - B23	01625044
483	195	16-4 - 253 - 200 - A23 - B23	01625045
586	245	16-4 - 294 - 262 - A23 - B23	01625046
683	295	16-4 - 353 - 300 - A23 - B23	01625047
783	345	16-4 - 403 - 350 - A23 - B23	01625048
883	395	16-4 - 453 - 400 - A23 - B23	01625049
983	445	16-4 - 503 - 450 - A23 - B23	01625050
1.083	495	16-4 - 553 - 500 - A23 - B23	01625051

All dimensions in mm. The standard color of the tube and the piston rod is black.

Gas spring Liftline Type 16-6 (standard program)

Ø tube 28 mm, Ø piston rod 14 mm, max. stroke 500 mm, extension force 200-1,800 N

Typ 16-6 Thread/Thread

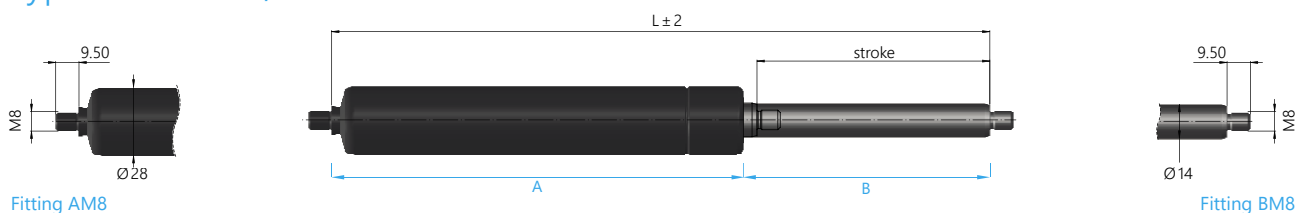

Select length, stroke and extension force

Length L (mm) ±2	Stroke (mm)	Technical data	Extension force F_1
218	70	16-6 - 118 - 100 - AM8 - BM8 -	Select the desired extension force F_1 : $200\text{ N} \leq F_1 \leq 1,800\text{ N}$ Please contact us for your individual layout.
268	98	16-6 - 168 - 100 - AM8 - BM8 -	
368	145	16-6 - 218 - 150 - AM8 - BM8 -	
468	198	16-6 - 268 - 200 - AM8 - BM8 -	
568	248	16-6 - 318 - 250 - AM8 - BM8 -	
668	298	16-6 - 368 - 300 - AM8 - BM8 -	
768	348	16-6 - 418 - 350 - AM8 - BM8 -	
874	398	16-6 - 474 - 400 - AM8 - BM8 -	
963	450	16-6 - 508 - 455 - AM8 - BM8 -	
1.070	500	16-6 - 565 - 505 - AM8 - BM8 -	

i Order example: **16-6 - 168 - 100 - A207 - B207 - 500N**
Type Tube (A) Piston rod (B) Tube (A) Piston rod (B) Extension force F_1
Length (mm) Fitting

i Please select your fittings on page 16/17



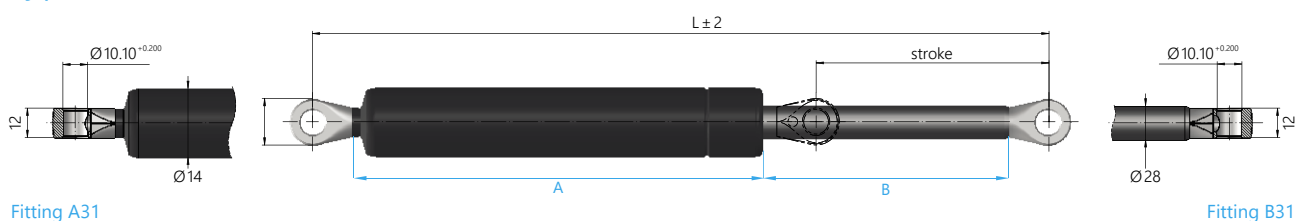

Typ 16-6 Clevis/Clevis, threaded





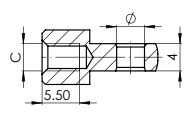
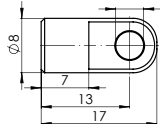

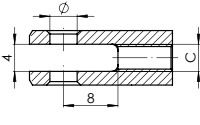
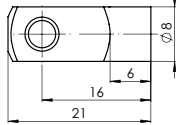

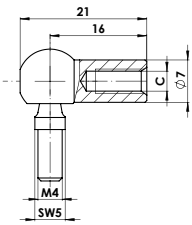
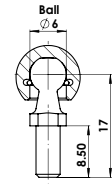

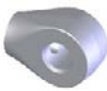
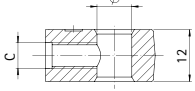
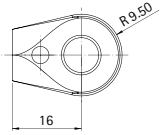

Length L (mm) ±2	Stroke (mm)	Technical data	Order number
250	70	16-6 - 118 - 100 - A31 - B31	01625089
300	98	16-6 - 168 - 100 - A31 - B31	01625061
400	145	16-6 - 218 - 150 - A31 - B31	01625062
500	198	16-6 - 268 - 200 - A31 - B31	01625063
600	248	16-6 - 318 - 250 - A31 - B31	01625064
700	298	16-6 - 368 - 300 - A31 - B31	01625065
800	348	16-6 - 418 - 350 - A31 - B31	01625066
906	398	16-6 - 474 - 400 - A31 - B31	01625067
995	450	16-6 - 508 - 455 - A31 - B31	01625068
1.102	500	16-6 - 565 - 505 - A31 - B31	01625069

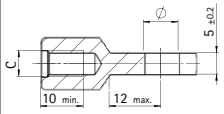
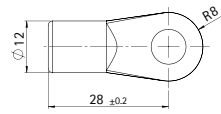
Fittings

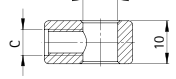
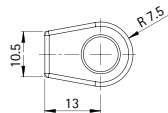
Type 16-12

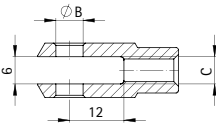
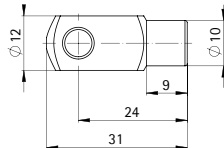

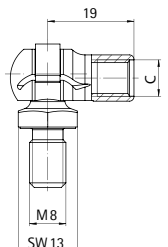
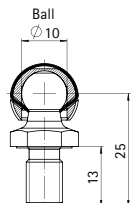

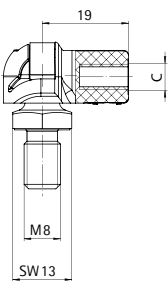
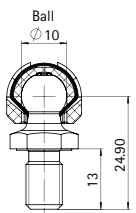

Fitting	Material	Attachement name	Order number	∅	C			
	Clevis	steel galvanized	A457 - B457	06710559	4.1	M4		
	Fork head	steel galvanized	A446 - B446	06710497	4	M4		
	Ball joint	steel galvanized	A456 - B456	16810007		M4		

Type 16-1 / Type 16-2

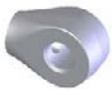
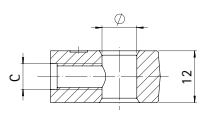
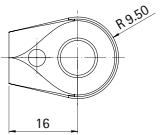

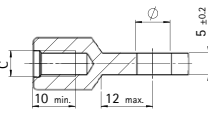
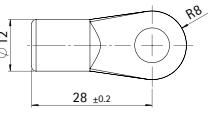

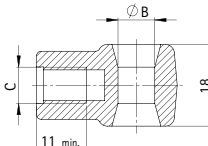
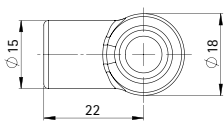
Fitting	Material	Attachement name	Order name	∅	C			
	Clevis	zinc	A104 - B104	06500078	12	M6		
			A220 - B220	06510005	6.1	M6		
			A221 - B221	06510006	8.1	M6		
			A222 - B222	06510007	10.1	M6		
	Clevis	zinc	A1 - B1	06500094	6.1	M6		
			A2 - B2	06500070	8.1	M8		
	Clevis	zinc	A10 - B10	06500164	8.1	M6		
			A223 - B223	06510008	6.1	M6		
	Fork-head	steel galvanized	A232 - B232	06810029	6	M6		
	Ball socket	steel black	A201 - B201	16800052		M6		
	Ball stud			06710041				
	Ball socket	plastic black	A246 - B246	16210000		M6		
	Ball stud	steel black		06710041				

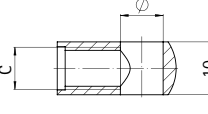
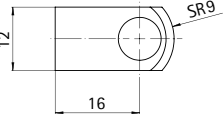
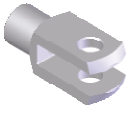
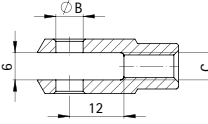
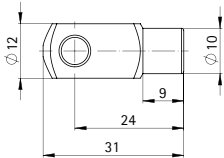
Fittings

Type 16-4 / Type 16-6

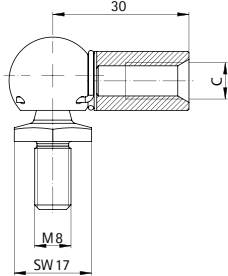
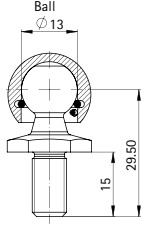
Fitting	Material	Attachement name	Order number	∅	C			
	Clevis	zinc	A26 - B26	06500029	12	M8		
			A30 - B30	06500155	8.1	M8		
			A31 - B31	06500145	10.1	M8		
	Clevis	zinc	A13 - B13	06500071	8.1	M8		
	Clevis	zinc	A20 - B20	06500191	8.1	M8		
			A111 - B111	06500525	10.1	M8		
	Clevis	steel black	A412 - B412	06760017	8.1	M8		
	Fork head	steel galvanized	A21 - B21	06800124	8	M8		

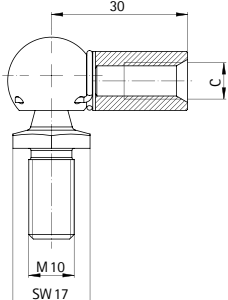
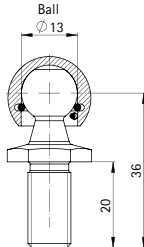
Type 16-4 / Type 16-6

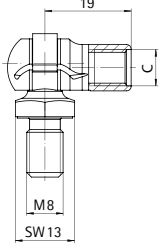
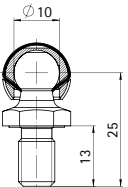
Fitting		Material	Attachement name	Order number	C		
	Ball socket	steel galvanized	A129 - B129	09700087	M8		
	Ball stud	steel black		06700116			
	Safety clip	stainless steel		06800019			
	Ball socket	steel galvanized	A199 - B199	09700087	M8		
	Ball stud	steel black		06700205			
	Safety clip	stainless steel		06800019			
	Ball socket	steel black	A207 - B207	16800055	M8		
	Ball stud	steel black		06710041			

Liftline Special functions

Standard gas spring or Soft-Stop gas spring

for example for furniture flaps

Standard gas springs as well as Soft-Stop gas springs are dampened on extension. After opening the flap slightly (as little as 10 degrees) both gas spring types will automatically lift the flap to the fully open position of approximately 90 degrees unassisted. In order to minimize vibrations, the speed is controlled over the entire range of opening by using a special hydraulic dampening (extension dampening) thus enabling a smooth opening. By presetting the filling pressure, it is possible to optimize the gas spring to any installation situation.

Advantages

- Extension speed is defined
- Automatic and noiseless opening function
- Smoothly cushioned movement throughout the entire opening procedure
- Gently slowing down the door/lid as it reaches full extension

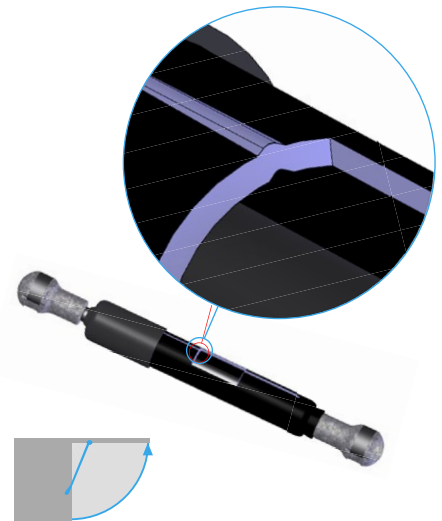

Positioning gas spring (Friction gas spring)

for example for furniture flaps

If a furniture flap needs to be used in many different positions, the positioning gas spring may be the right solution. This gas spring supports the load in any position desired by the user. Doors/lids can be positioned infinitely throughout their complete range of motion. By careful adjustment of the pressure during filling, the gas spring can be optimized to the application.

Advantages

- Counterbalance for loads during the opening function
- The ability to hold or position the door infinitely at any position in its range of motion

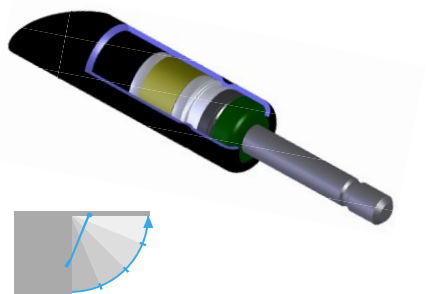

Gas spring with protective cap

If the gas spring is used in a particularly dirty or dusty environment, it may be necessary to protect the seal by using protective caps made of rubber or plastic. The protective cap is intended to ensure that no dirt and dust particles in the environment penetrate into the pneumatic spring seal when actuating the flap. Using the protective cap therefore also has a positive effect on the service life of the gas spring in these installation situations.

In an extremely dirty environment, the protection that is guaranteed by the protective cap may not be sufficient. In these extreme environmental conditions, it is advisable to use a Space-Mat gas spring (gas spring with lubrication reservoir).



Space-mat: gas spring with lubrication reservoir

The gas spring with lubrication reservoir is based on the space-mat principle. This principle means that a plastic foam placed around the piston rod absorbs lubricants into the cavities by capillary action and releases them again purposefully when lubrication is required. The service life of the gas spring is markedly improved as a result, especially if used in technically demanding surroundings (dirt and dust).

Advantages

- Suitable for technically demanding surroundings (dirt and dust)
- Suitable for special installation situations (e.g. piston rod upside)



TouchLift: gas spring that locks in the retracted position

The SUSPA TouchLift is a gas spring that locks itself in the retracted position. In this way, for example, covers can be kept in the lowered position. Slight pressure on the cover releases the lock and the gas spring extends.

The lock works according to the so-called ballpoint pen principle:

- Press once and the gas spring locks in place
- Press once more and the gas spring extends

Applications

By using the SUSPA TouchLift gas spring, furniture elements can be retracted so that their lid cover is flush with the respective surface. The objects can be raised and retracted simply by pressing the cover.

- Retracting flat screens
- Retracting outlet strips
- A minibar to be retracted
- Lifting and lowering functions for head rests or arm rests of sofas

Advantages

The main advantages of the SUSPA TouchLift is the very low noise and the 7 mm travel of release. The TouchLift gas spring works without electricity, therefore, no cables or batteries are required and no electricity costs are incurred. Its service life corresponds with that of a classic gas spring, i. e. approximately 50,000 cycles.





Lockable gas spring Lockline

The locking gas strut aids the ergonomics and comfort for conveniently safely changing seated and lying positions, for effortlessly and precisely operating machine covers and are used in many other applications.

Our lockable gas struts make it possible to variably lock them in any stroke position, whether elastically (“spring-loaded”) or rigidly. Our special functions offer particular advantages when it comes to convenience and operation.

Different connection elements and release systems complete our range of products and give you the appropriate lockable gas strut for any application.

Elastic locking

Type	Ø Tube (mm)	Stroke (mm)	Extension force F_1 (N)	Type of locking
EL1*	22	10 - 450	80 - 800	elastic
EL2*	28	10 - 450	80 - 1,000	elastic

Rigid locking

HY1*	22	100 - 300	80 - 800	rigid in the tensile direction
HY3*	28	10 - 450	80 - 1,000	rigid in the tensile direction
HY4	28	10 - 300	80 - 1,000	rigid in the compressive direction
HY6	27	150 - 450	70 - 400	rigid in the compressive direction
VOB	28	70 - 300	150 - 1,000	rigid in the compressive direction

* Standard program, pages 23-25

Applications

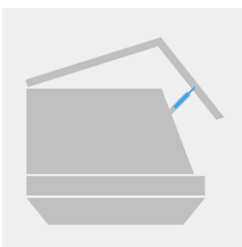

Machinery lids



Medical



Commercial vehicle seats

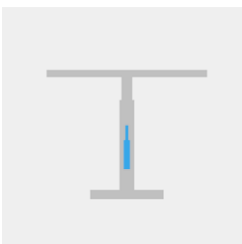

Side tables



Steering columns

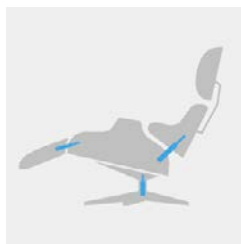

Relax chairs

Lockable gas spring Lockline

Design and functionality

Working principle

Gas springs consist of a gas pressurized tube together with a piston rod and piston. The piston is fitted with a valve that is actuated by the release pin. When the valve is shut, the gas spring does not move, thus providing locking in the desired position.

Depending on the pressure medium, this locking feature can be either **rigid** or **elastic**.

Type of locking

Rigid locking in extension (HY1 and HY3) is used when a cushioning effect in the locking position is not desired – for example, for safety reasons. Rigid locking in compression (HY4, HY6 and VOB18-1) is recommended for light weight applications that are subject to high compression forces when locked and require no movement. The VOB18-1 and HY6 are ideal for applications that require a short installation length and a large stroke (Please find detailed information in our product catalog „Lockable gas springs“).

Elastic-locking gas springs EL1 and EL2 are recommended when the locking feature is required to have a cushioning effect. Sudden jolted loads can thus be dampened or even completely avoided.

Spring characteristic

As the graphic illustration indicates, the spring characteristic curve represents the force curve of the gas spring over the stroke, from the extended to the compressed state. The progression thereby represents the force ratio F_2/F_1 in extension direction. To be able to design a gas spring, force F_1 apart from the dimensions, is an important measuring criterion. Force F_1 is measured 2 mm from the end of the extension movement and defines the value of the spring force. Force $F_{R'}$, resulting from friction, develops between the force lines in the direction of retraction and extension. The extension speed can be defined by adjusting the piston assembly corresponding to available stages.

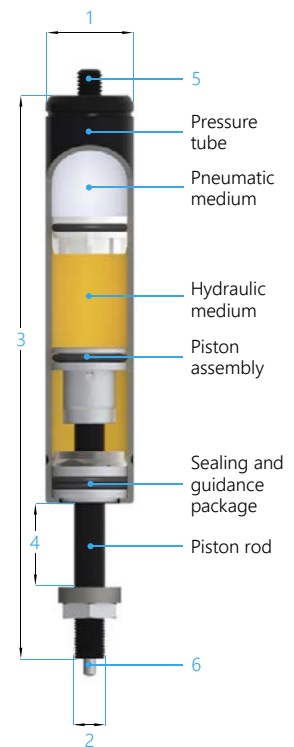

- 1 Diameter tube
- 2 Diameter piston rod
- 3 Installation length
- 4 Stroke
- 5 Fitting tube
- 6 Release pin

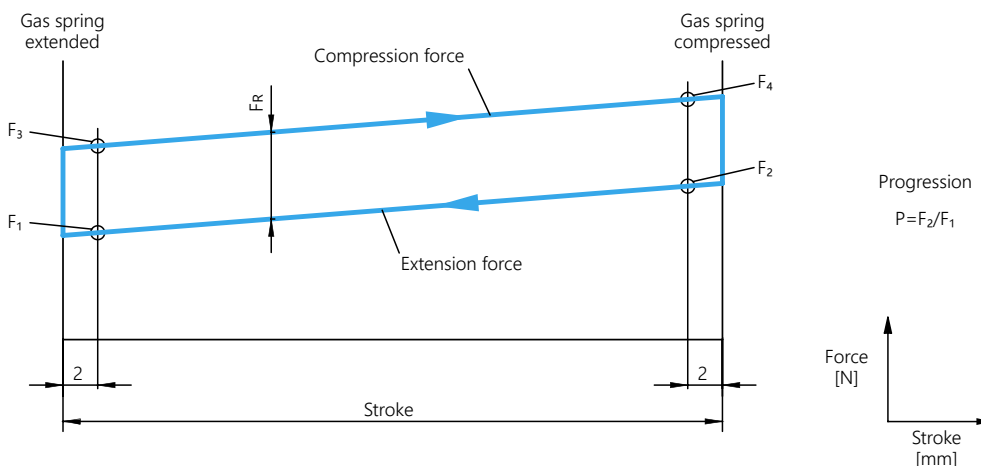

Standard program – technical specifications

Elastic locking

Specification	EL1	EL2
Release pin	on piston rod side	
Locking	elastic	
In compression direction: max. load [N]	6,500	10,000
In extension direction: max. load [N]	3,500	7,000
Tube diameter [mm]	22	28
Piston rod diameter [mm]	10	
Stroke C [mm]	20 - 250	20 - 250
Extension forces F_1 [N]	200 - 800	200 - 1,000
Progression ratio (F_2/F_1)	~1.30	~1.20
Release force [N]	$0.25 \times F_1$	
Release travel, normal [mm]	$2.5 \leq x \leq 3.5$	
Recommended installation position	piston rod pointing downwards	
Permissible operating temperature	-20 °C to +60 °C	
Permissible storage temperature	-20 °C to +80 °C	

Rigid locking

Specification	HY1	HY3
Release pin	on piston rod side	
Locking	rigid in tensile direction	
In compression direction: rigid until [N]/max. load [N]	$3.6 \times F_1/6,500$	$5.8 \times F_1/10,000$
In extension direction: max. load [N]	3,500	7,000
Tube diameter [mm]	22	28
Piston rod diameter [mm]	10	
Stroke C [mm]	20 - 250	20 - 250
Extension forces F_1 [N]	200 - 800	200 - 1,000
Progression ratio (F_2/F_1)	~1.60	~1.40
Release force [N]	$0.25 \times F_1$	
Release travel, normal [mm]	$2.5 \leq x \leq 3.5$	
Recommended installation position	any	any
Permissible operating temperature	-20 °C to +60 °C	
Permissible storage temperature	-20 °C to +80 °C	

Specification rigid locking

Type	Ø Tube (mm)	Ø Piston rod (mm)	Stroke (mm)	Extension force * F ₁ (N)	Color tube	Color piston rod	Type of locking
HY1	22	10	20 - 250	200 - 800	black	tenifer	rigid
HY3	28	10	20 - 250	200 - 1,000	black	tenifer	rigid

* The extension force is selectable in steps of 50 Newton.

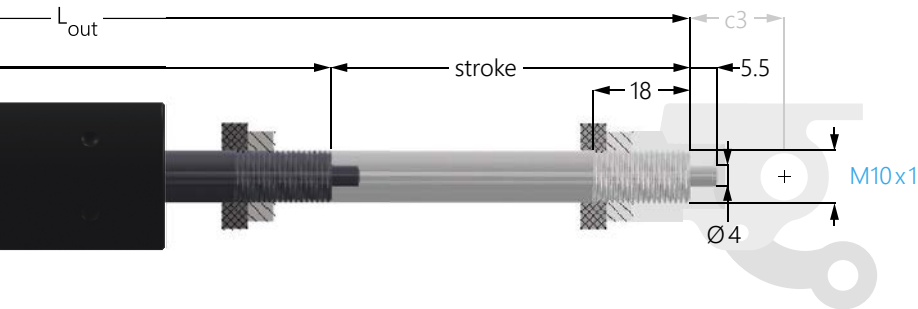

End fittings B

Technical data

Length (mm)		Stroke (mm)	Type	Order no.
L _{out}	L _{in}			
130	110	20	HY1	02852477
			HY3	02852488
160	130	30	HY1	02852478
			HY3	02852489
190	150	40	HY1	02852479
			HY3	02852490
230	170	60	HY1	02852480
			HY3	02852491
270	190	80	HY1	02852481
			HY3	02852492
330	230	100	HY1	02852482
			HY3	02852493
390	270	120	HY1	02852483
			HY3	02852494
470	310	160	HY1	02852484
			HY3	02852495
570	370	200	HY1	02852485
			HY3	02852496
710	460	250	HY1	02852486
			HY3	02852497

SusflexRegular

axial release: cable mounted parallel to gas spring

Force ratio	Eyelet d = 8 mm	Eyelet d = 10 mm
1:2	06550018+ 06550020	06550019+ 06550020

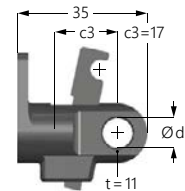

SusflexSide

90° release: cable mounted perpendicular to gas spring

Force ratio	Eyelet d = 8 mm	Eyelet d = 10 mm
1:2	02152022	02152021

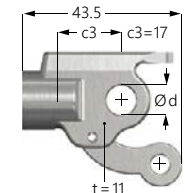

SusflexDirect

for lever release

Type	Eyelet d = 8 mm	Eyelet d = 10 mm
standard	02100075	02150102

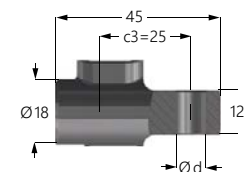

Lockline Special functions

AntiShock AS

Convenience and safety

The "AntiShock" module detects the load situation of the application and acts accordingly. When used in an office chair with dynamic free-swinging, the lockable gas spring with AntiShock provides the user with smooth moving action (comfort function). In addition, it will return the non-loaded backrest slowly from the reclined to the vertical position when released. Thus it will avoid the so-called catapult effect (safety function).

In the case of height-adjustable tables which have a low intrinsic weight but are subjected to high loads when in use (Varilock with a high extension force), the Varilock allows a quick height adjustment of the loaded table and, thanks to AntiShock, also prevents the tabletop rising up too quickly when the empty, unloaded table is released.



EasySwitch ES

Locking that can be switched on and off

With the "EasySwitch" module, the user controls the valve "digitally", alternating between the closed and permanently open position and back again. You switch between the two modes by activating the pin through the release mechanism.

With EasySwitch, the valve stays either open (swinging function) or closed (locked backrest) as per the user's settings.

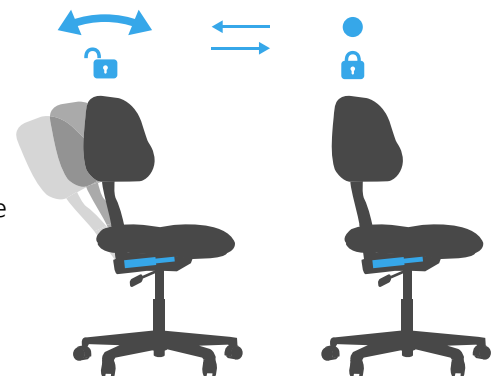

OverRide OR

Smooth extension without actuation

The "OverRide" module allows a person to move the application in the extension direction without having to activate the release function. In the case of desk or table applications, a gentle upwards force applied to the tabletop adjusts the height of the table. Once the desired position has been achieved, locking in the compression direction is rigid.

OverRide provides smooth, comfortable operation and was first designed for use in hospital beds and over-bed tables. It also allows for single-hand operation of the application.

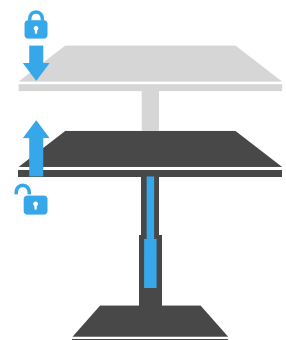

TimeReset TR Automatic return

The "TimeReset" automatically detects whether the application is charged with a person's weight or not. When loaded, the Varilock operates in the usual manner and permits locking at any position. When the application is not loaded, the Varilock returns it to the starting position (vertical backrest) within a custom defined time period.

TimeReset is particularly suitable for passenger seats, cinema and theatre seating or conference chairs.

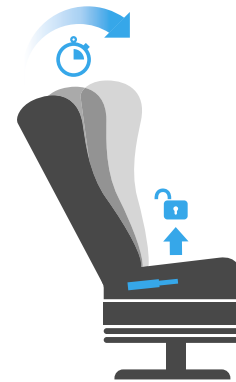

ComfortReleaseLow CL Extremely easy operation of gas struts

Using the "ComfortReleaseLow" module can adjust the lockable gas strut to the requirements of any release system in order to achieve maximum operating comfort. Conventional valve designs (standard release) cannot be conveniently triggered in the event of high extension forces. SUSPA ensures a convenient release through the lowest possible manual force on the actuating element (button, lever). We are happy to advise you in the optimization of your application.

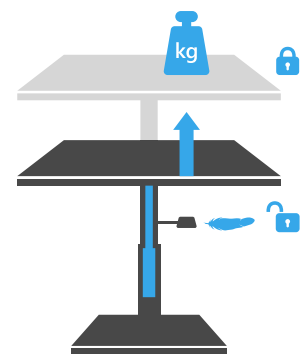

Lightweight lockable gas strut

Lockable gas struts for aviation are ideal for the comfortable and safe adjustment of the sitting and lying position of passenger and pilot seats.

Characteristics

- Optimized weight due to the aluminum piston rod (60% weight savings compared to a conventional piston rod made of steel with the same performance)
- High strength of the tube even with a smaller wall thickness (25% compared to conventional tubes)
- Low release force
- High spring stiffness

Application examples

- Backrest adjustment in passenger and pilot seats
- Leg rest for business and first class seats





Damper Softline

The SUSPA hydraulic dampers, also called shock absorbers, industrial shock absorbers or vibration dampers, are designed for the respective product application so that an optimal movement sequence or optimal vibration behavior is achieved. We use our decades of experience in the field of damping technology to solve your individual requirements for damping vibrations and impacts.

Type	Ø Tube (mm)	Ø Piston rod (mm)	Damping forces (N)
HD 12	12	4	50 - 400
HD 13	13	5	50 - 400
HD 15	15	6	50 - 500
HD 18	18	8	0 - 2,000
HD 22	22	10	50 - 2,500
HD 25*	25	8	100 - 4,000
HD 34	34	8	100 - 5,000
HD 38	38	10	100 - 6,000

* Standard program, page 31

Applications

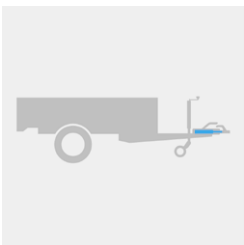

Overrun brakes

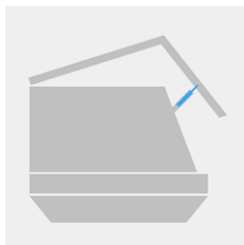

Machinery lids

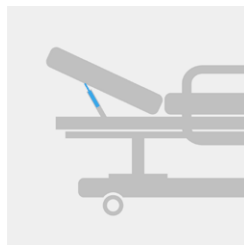

Medical

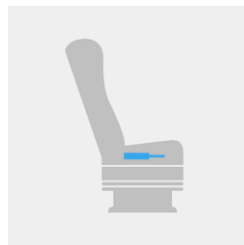

Commercial vehicle seats

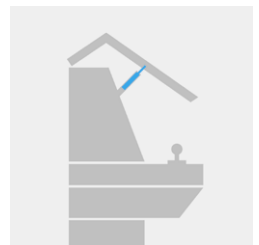

Slot machines

Damper Softline

Design and functionality

When the piston rod is moved, the damping medium of oil is pressed through the bores in the piston system. The damping force results from the resistance of the oil when flowing through the piston system. Due to the internal design of the piston system, the pull and push direction can be set independently of each other. The damping forces are dependent on the piston speed.

When the piston rod is moved, the damping medium of oil is pressed through the bores in the piston system. The damping forces are dependent on the piston speed.

Damping forces

Because the damping holes can be closed respectively to either side by way of valve washers, it is possible to regulate the damping forces in extension and compression directions largely independent of one another. The damping force upon compression determines the hardness of a shock absorber upon retraction. The damping force upon extension regulates the extension speed.

Characteristic curve

Adjustable linear, progressive or degressive characteristic curves allow for the application-oriented design of the hydraulic damper.

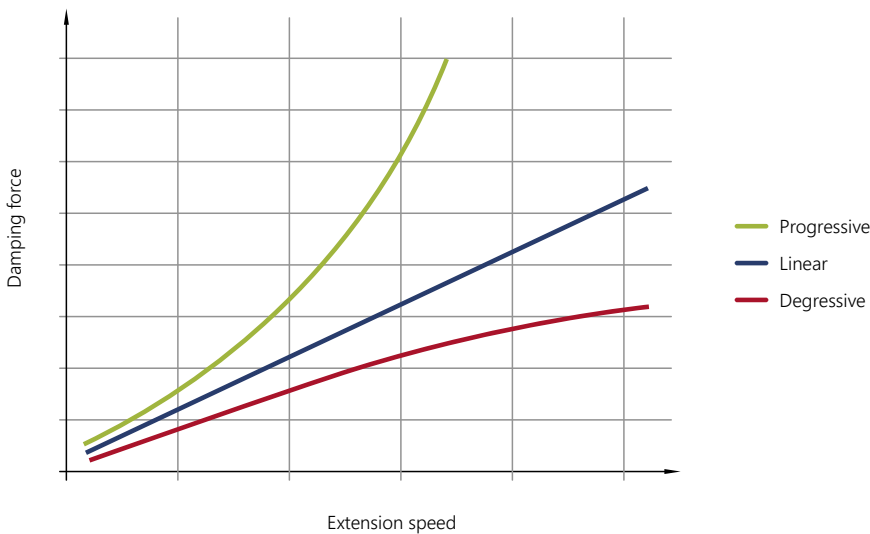
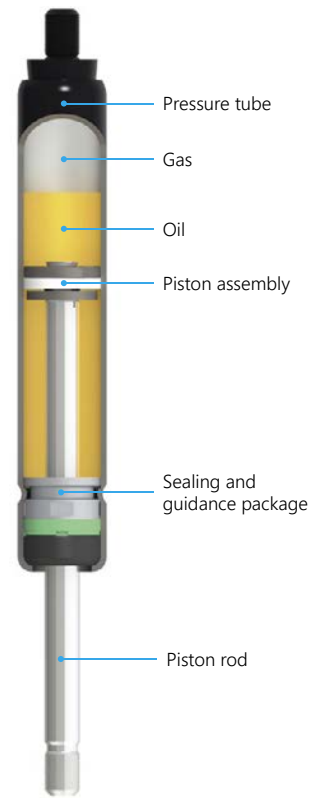

Damper Softline Type HD 25

Type	Ø Tube (mm)	Ø Piston rod (mm)	Hydr. stroke (mm)	Mech. stroke (mm)	Damping forces (N)	Color tube	Color piston rod
HD25	25	8	91 - 206	91 - 206	100 - 4,000	black	chrome

Hydraulic damper

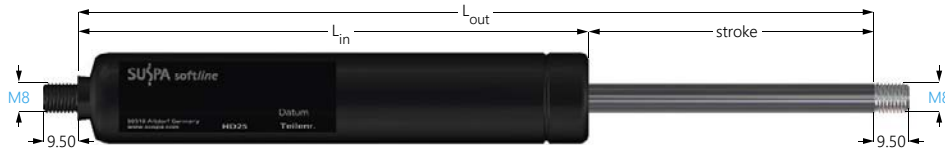

End fittings A

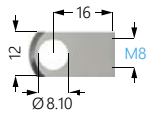

Clevis A412

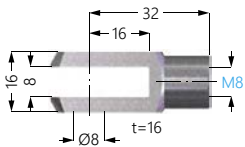

Fork head A21

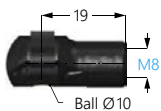

Ball joint A202

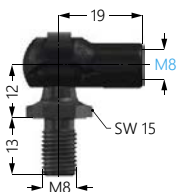

Ball joint A207

Technical data

Length (mm)		Stroke (mm)		Damping forces (N) ¹		Order no.
L _{out}	L _{in}	Hydr.	Mech.	Tension	Comp.	
231	140	91	91	650	< 100	01110650
				1,500	< 100	01110651
308	179	105	129	< 100	650	01110653
				< 100	1,500	01110654
				< 100	4,000	01110655
320	179	141	141	650	< 100	01110656
				1,500	< 100	01110657
426	238	153	188	< 100	650	01110659
				< 100	1,500	01110660
				< 100	4,000	01110661
498	292 ²	206	206	650	< 100	01110662
				1,500	< 100	01110663
498	292 ²	166	206	< 100	650	01110665
				< 100	1,500	01110666
				< 100	4,000	01110667

¹ Test speed linear: 100 mm/s

² With this length the actual value of the compressed length is different from the list above.

All figures in mm

End fittings B

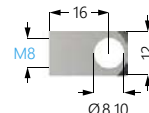

Clevis B412

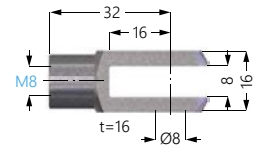

Fork head B21

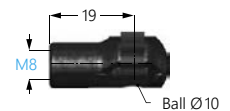

Ball joint B202

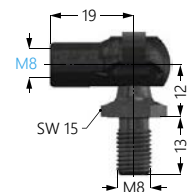

Ball joint B207

i Ordering system
(only for orders with end fittings)

Order number

01110653

End fittings

- A412 - B202
Tube-
end fitting A Piston rod-
end fitting B

Damper Softline Variations

Depending on the applications you can choose the dampers in the following versions:

Version	Idle stroke	Independence of position	Extension force	Adjustability
Standard	yes	no	no	no
with gas pressure (GD)	no	no	yes	no
with gas pressure and separator piston (GDTK)	no	yes	yes	no
with bottom valve (BV)	no	no	no	no
with bottom valve and diaphragm (BVM)	no	yes	no	no
Twin tube	no	no	no	yes

Type	Standard	Gas pressure (GD)	Gas pressure and separator piston (GDTK)	Bottom valve (BV)	Bottom valve and diaphragm (BVM)	Twin-Tube
HD 12	•	•				
HD 15	•	•				
HD 18	•	•	•			
HD 22	•	•				
HD 25*	•		•	•	•	
HD 34						•
HD 38						•

* Standard program, page 31

Damper Softline Variations

Standard

The classical standard damper with throttling port and valve system for diverse applications. A vacant space remains in the pressure tube for the volume of the piston rod. A slight idle stroke results, meaning that damping force only occurs after several millimeters of path.

Characteristics

- Without extension force F_1
- With idle stroke
- Fixed position

Application examples

Waste container, counter, medical, furniture, automotive interior, overhead compartments

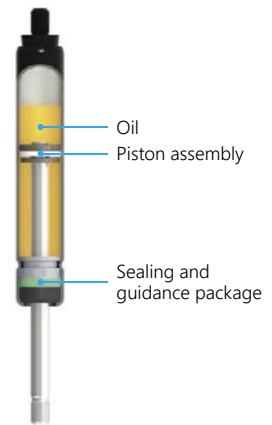

Damper with gas pressure

The vacant space is filled with gas in this version. This damper is therefore usable independent of installation position.

Characteristics

- With extension force F_1
- Without idle stroke
- Independent position

Application examples

Automobile trunks, glove compartments, various flaps

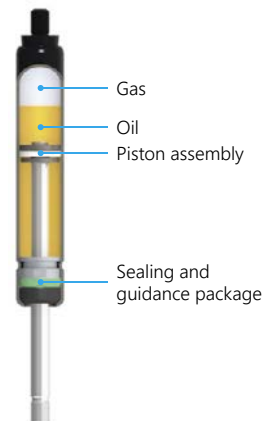

Damper with gas pressure and separator piston

In this version, the oil chamber is separated from the gas compartment, which is under pressure, by a sealing separator piston. The damper can therefore be installed in any position desired and possesses no idle stroke. This has as a consequence that the damping force immediately sets in upon load condition.

Characteristics

- With extension force F_1
- Without idle stroke
- Independent position

Application examples

Waste container, overrun brakes, automotive interior, commercial vehicle seats

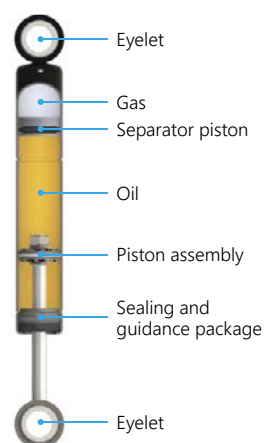

Damper Softline Versions

Damper with bottom valve

The oil chamber is separated from the gas compartment by way of a bottom valve in this type of damper. For specific applications: Idle stroke freedom is achieved without extension force.

Characteristics

- Without extension force F_1
- Without idle stroke
- Fixed position

Application examples

Counter, automotive interior, motor vibration damper, belt tensioners, commercial vehicle seats

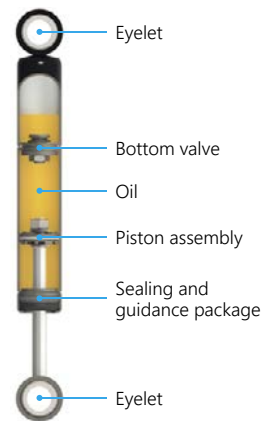

Damper with bottom valve and diaphragm

The diaphragm in the balance chamber, behind the bottom valve, expands upon load (compression) and contracts upon extension. For specific applications: Idle stroke freedom without extension force is achieved for independent choice of installation position.

Characteristics

- Without extension force F_1
- Without idle stroke
- Independent position

Application examples

Overrun brakes, commercial vehicle seats, belt tensioners

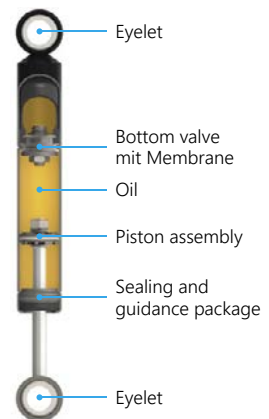

Twin-Tube

Two tubes with unlike diameters are arranged concentrically. The inner tube represents the working area. The space between the inner and outer tubes is the balance chamber that takes up the oil pressed out by the retracting piston rod.

Especially worthy of mention are the freely adjustable forces possible in the extension and compression directions. In addition, the extremely light weight of the damper which is achieved by the use of an aluminum outer tube.

Characteristics

- Diameter outer tube 38 mm (aluminum tube)
- Diameter piston rod 10 mm
- Damping force max. 6,000 N
- Without extension force F_1
- Fixed position (installation with piston rod pointing upward)

Application examples

Commercial vehicle seats (vertical damping)

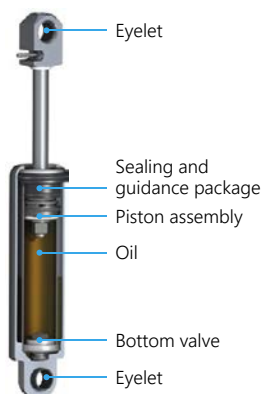

Damper for aviation

The lightweight damper is in particular used in stowage compartments and guarantees a gentle downward-opening. The optimized weight is achieved with this damper due to the small design.

Characteristics

- Wide range of the damping force
- Optional manual force support
- Elegant due to the compact design

Application example

Overhead compartments





Piston rods and Tubes

Rotary and translatory moving piston rods, shafts and tubes meet the highest quality standards due to our decades-long expertise. The precisely coordinated production steps of turning, hardening, grinding, surface coating and polishing ensure a high surface quality. Even complex geometries can be manufactured with high accuracy on CNC machines with several axis - economical and established in millions of applications.

	Characteristics
Ø Piston rod	4 mm - 28 mm
Ø Tube	4 mm - 70 mm
Length	35 mm - 700 mm
Roughness	Ra 0.05 µm/Rz 0.5 µm
Material	steel, stainless steel, aluminum
Surface refinement	hard chrome plating, salt bath or gas nitration, DLC, browning, galvanizing, passivating

Applications

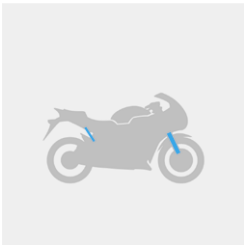

Vibration damper

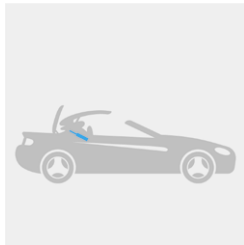

Convertible

Piston rods and tubes

Production Expertise

CNC Turning

With the latest multi-axis CNC turning machines, we offer you conventional cam-controlled, simple turning as well as the economical complete machining of turned parts in one clamping.

Hardening

Inductive through-hardening ensures the hardening of predetermined zones in the component. It is a technology that can be customized to your needs.

Centerless through-feed grinding

SUSPA grinding lines ensure high throughput speeds and optimal economic efficiency. You can expect an optimal surface quality with roughness values up to Ra 0,1 µm, depending on the material and diameter requirement.

Surfaces

Hard chrome plating, salt bath nitriding, gas nitriding, DLC, black finishing, zinc plating, passivation achieve high corrosion resistance and wear resistance. This means extremely large load changes over the entire service life for your products.

Polishing

The prerequisite of a tribological system is a flawless surface, which we achieve through a final optimized finishing, without a significant removal of material.

Flexibility

A provision of our components adapted to your logistics requirements in the batch sizes you need is a matter of course.





Height Adjustment



Height adjustment Office

Ergonomics in the workplace

Over the last few years, SUSPA has become established as one of the leading suppliers of electric height adjustment systems. The topic of ergonomics in the workplace has increasingly gained importance in companies in recent years.

Since more and more people are experiencing back problems due to a lack of movement, it is not only the personal well being that is affected, but there is also enormous economic damage done through absences from work.

The best way of countering the lack of movement in the office is to use sit-stand desks.

Type	Characteristics
Electric columns ELS3	<ul style="list-style-type: none"> • elegant design, many colors and profiles • adjustment range to 650 mm • fast and quiet movement
Table base frame VariFrame	<ul style="list-style-type: none"> • split and variable crossbeam (for different table top sizes)
Table base frame FixFrame	<ul style="list-style-type: none"> • fixed cross beam • in five sizes
Table base frame ELS3 Bench	<ul style="list-style-type: none"> • for duo workplaces • for table base frame VariFrame or FixFrame
Table base frame accessories	<ul style="list-style-type: none"> • controllers • switches
Pneumatic table column VariStand	<ul style="list-style-type: none"> • 1-leg table • table column round
Pneumatic table column Vari-Base	<ul style="list-style-type: none"> • 1-leg table • table column square

Applications



Office table



Side table

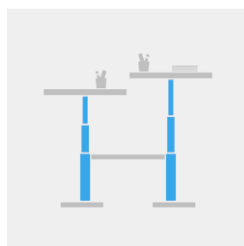

Duo workplace



Please find the assembly instructions for all adjustment systems online at www.suspa.com/global/downloads/

Electric height adjustment

Columns ELS3



Model name		ELS3-500S-BTD-Q	ELS3-500S-BTU-Q	ELS3-650-BTD-Q	ELS3-650-BTU-Q
Profile		square version			
Positioning of big tube		Big Tube Down (BTD)	Big Tube Up (BTU)	Big Tube Down (BTD)	Big Tube Up (BTU)
Material		steel profile			
Color		● silver-gray RAL9006		○ white RAL9003	● black RAL9005
Design		1-stage telescopic	1-stage telescopic	2-stage telescopic	2-stage telescopic
Compressed length		650 mm	650 mm	565 mm	565 mm
Adjustment range (stroke)		500 mm	500 mm	650 mm	650 mm
Extended length		1,150 mm	1,150 mm	1,215 mm	1,215 mm
Maximum load	with controller SMART	60 kg/leg	60 kg/leg	50 kg/leg	50 kg/leg
	with controller COMPACT	-	-	60 kg/leg	60 kg/leg
Adjustment speed		35 mm/s	35 mm/s	38 mm/s	38 mm/s
Dimension of columns	top	65 x 65 mm	70 x 70 mm	60 x 60 mm	70 x 70 mm
	middle	-	-	65 x 65 mm	65 x 65 mm
	bottom	70 x 70 mm	65 x 65 mm	70 x 70 mm	60 x 60 mm
Dimensions of motor casing / top		202 x 120 x 56 mm			
Fixing for the footbase		4 x M8			



Further colors available on request



Lifting column
rectangular version

ELS3-500S-BTD-RE	ELS3-500S-BTU-RE	ELS3-650-BTD-RE	ELS3-650-BTU-RE
rectangular version			
Big Tube Down (BTD)	Big Tube Up (BTU)	Big Tube Down (BTD)	Big Tube Up (BTU)
steel profile			
● graphite RAL7024	further colors available on request		
1-stage telescopic	1-stage telescopic	2-stage telescopic	2-stage telescopic
650 mm	650 mm	565 mm	565 mm
500 mm	500 mm	650 mm	650 mm
1,150 mm	1,150 mm	1,215 mm	1,215 mm
60 kg/leg -	60 kg/leg -	50 kg/leg 60 kg/leg	50 kg/leg 60 kg/leg
35 mm/s	35 mm/s	38 mm/s	38 mm/s
101x61 mm -	107x67 mm -	95x55 mm 101x61 mm 107x67 mm	107x67 mm 101x61 mm 95x55 mm
202 x 120 x 56 mm			
4 x M8			

VariFrame

Electric adjustable table base frame Office

The SUSPA table subframe is suitable for a wide range of applications and easy to assemble. The frames were specifically designed for our ELS3 range of adjustable legs and can be used with different legs, controller or switches.

The adjustable table base VariFrame comes with a split cross beam which is variable and can be adjusted to different table top sizes.



Model name		Table base frame VariFrame
Top frame		
Color		● silver-gray RAL9006 ○ white RAL9003
Cross beam	length	two-piece traverse, adjustable length of frame from 1,140 mm to 1,940 mm
Desk top dimension	length	1,200 - 2,000 mm
	depth	700 - 800 mm
Material		steel profile
Fixing plate	length	735 mm
Adjustment range (stroke) until top of frame		ELS3-500S: 700 - 1,200 mm ELS3-650: 620 - 1,270 mm
Maximum load table frame		100 kg
Adjustment speed		ELS3-500S: 35 mm/s ELS3-650: 38 mm/s
Accessories		screws, adjustable feet
For lifting columns		can be combined with all SUSPA columns

Foot base

Type		FA2
For lifting columns		can be combined with all SUSPA columns
Dimensions	length	750 mm
	depth	90 mm
	height	30 mm



FixFrame

Electric adjustable table base frame Office

The table base FixFrame consists of a fixed cross beam, available in five different sizes. We offer control boxes and switches for the VariFrame as well as for the FixFrame (see pages 48 und 49).

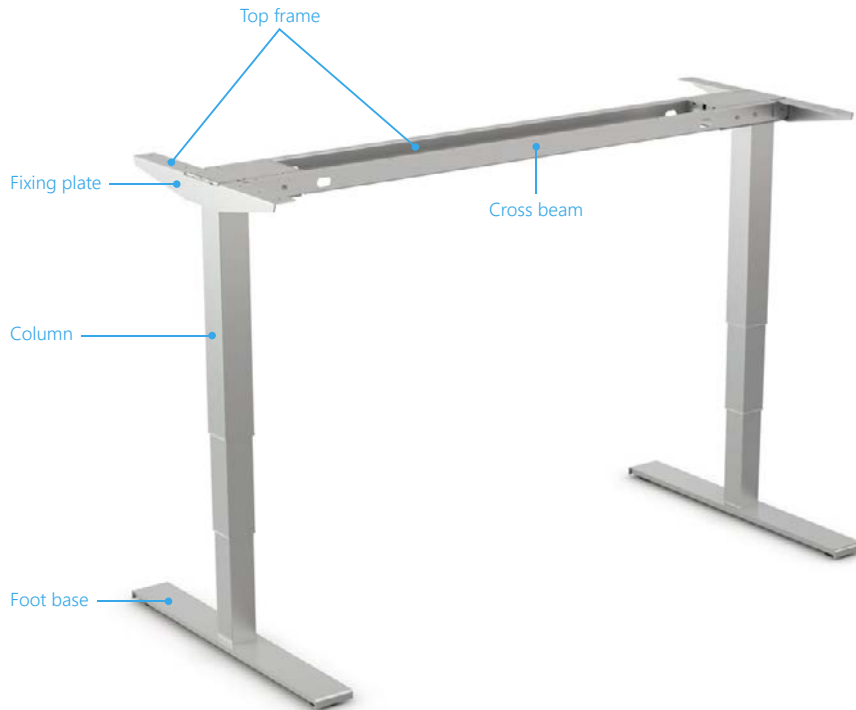

Model name		Table base frame FixFrame
Top frame		
Color		<input type="radio"/> silver-gray RAL9006 <input type="radio"/> white RAL9003 <input type="radio"/> black RAL9005 <input type="radio"/> graphite RAL7024
Traverse	length	fixed cross beam lengths: 1,140 mm, 1,340 mm, 1,540 mm, 1,740 mm, 1,940 mm
Desk top dimensions	length depth	1,200 mm, 1,400 mm, 1,600 mm, 1,800 mm, 2,000 mm 700 - 800 mm
Material		steel profile
Fixing plate	length	545 mm
Adjustment range (stroke) until top of frame		ELS3-500S: 680 - 1,180 mm ELS3-650: 600 - 1,250 mm
Maximum load table frame		100 kg
Adjustment speed		ELS3-500S: 35 mm/s ELS3-650: 38 mm/s
Accessories		screws, adjustable feet
For lifting columns		can be combined with all SUSPA columns

Foot base

Type		FA2
For lifting columns		can be combined with all SUSPA columns
Dimensions	length depth height	750 mm 90 mm 30 mm



ELS3 Bench

Electric adjustable table base frame Office for duo workplaces

For team workplaces we offer a complete table base frame, suitable for table tops from 1,200mm to 2,000mm. With the so called bench-solution you will achieve the ideal use of space in your office.

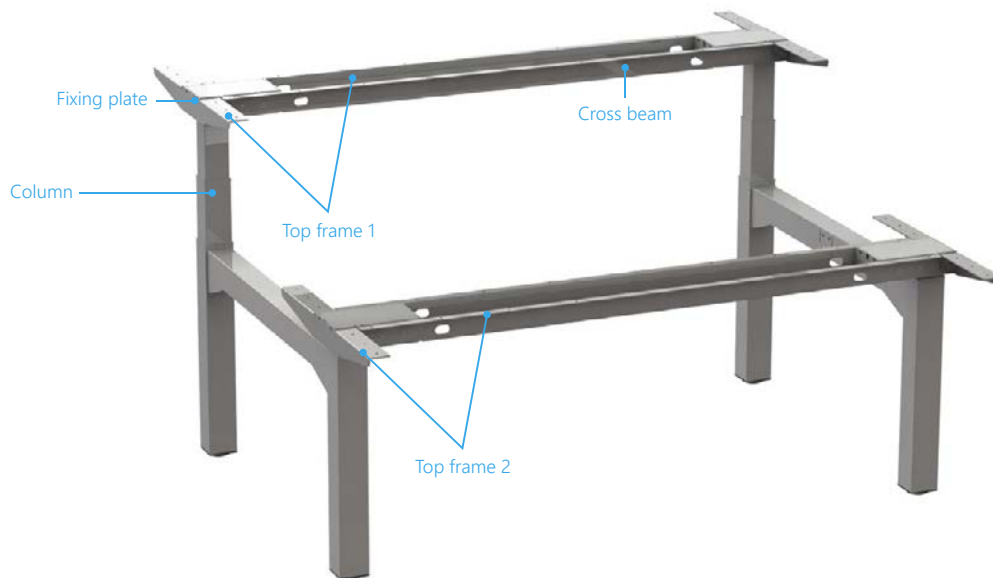

Model name		Table base frame Bench
Top frame		
Color		● silver-gray RAL 9006 ○ white RAL 9003
Cross beam	length	see VariFrame or FixFrame, pages 46 und 47
Desk top dimension	length depth	1,200 mm, 1,400 mm, 1,600 mm, 1,800 mm, 2,000 mm 700 - 800 mm
Material		steel profile
Fixing plate	length	545 mm
Accessories		screws, adjustable sliding feet
For lifting columns		for lifting columns for all square columns BTD (Big Tube Down)



Hand switch
Up-Down
HSM-OD-2-LD



Hand switch
Up-Down
TOUCHbasic DN



Hand switch
Up-Down, Inlay
TOUCHbasic IL

Accessories and switches

Control boxes

The highly efficient control boxes have a flat and compact design. In combination with the switches they guarantee a reliable and economical operation of the tables.

SMART controller



- Low standby power consumption: $\leq 0,3$ W
- Soft-Start and Soft-Stop
- Overload protection
- Small size and flat design
- Weight: 305 g
- Dimensions: 186x100x30 mm
- Input voltage: 230V/50Hz
- Output voltage: 216VA (2-leg) 24VDC
- Operating time 10% at maximum load (1min/9min)
- Controls for EU- and US-voltage available

COMPACT controller



- Low standby power consumption: $\leq 0,3$ W
- Soft-Start and Soft-Stop
- Overload protection
- Weight: 418 g/523 g (3-leg-controller)
- Dimensions: 264x103x37 mm
- Input voltage: 230V/50Hz
- Output voltage: 288VA (2-leg) 24VDC/360VA (3-leg) 24V DC
- Operating time 10% at maximum load (1min/9min)
- Controls for EU- and US-voltage available
- External sensor collision detector possible with LOGIC-CONNECTOR

Communication and Connectivity LOGIClink

LOGIClink provides connectivity and control, allowing for communication and customization of the user's work environment.



Power cable

available for the control boxes COMPACT and SMART for different countries

Switches

We provide solutions for an installation below the table and within the table top. From a simple hand switch with Up/Down function to a comfort switch with four memory functions and display – all operational elements satisfy through their surface design and the pleasing haptics.



Hand switch
Memory
HSU-MDF-4M2-LD



Hand switch
Memory
TOUCHfx



Hand switch
Memory, Inlay
TOUCHinlay

VariBase

Height-adjustable table column (square column)

The pneumatic height adjustable system VariBase is a professional and extremely robust holistic solution for table applications. It is particularly characterized by ease of handling and Plug & Play installation. VariBase stands out for its application with a long service life and offers comfortable height adjustment.

VariBase is available in versions Big Tube Up (BTU) or Big Tube Down (BTD).

Characteristics	Values		
Dimension BTU (Big Tube Up)	□ 70/□ 65 mm		
Dimension BTD (Big Tube Down)	□ 60/□ 65 mm		
Length when extended (L_{out})	1,040 mm	815 mm	655 mm
Stroke	400 mm	290 mm	215 mm
Length when compressed (L_{in})	640 mm	525 mm	440 mm
Stroke force	120 N, recommended weight of table top ~ 6 kg, further F_1 -force on request (70 - 400 N)		
Surface finishing	Powder coated (RAL9006), further RAL-colors on request		
Activation/ release	Lever, cable release		
Tabletop fitting	lange adapter (with 12 drillholes, distance 32 mm)		
Base fitting	Flange with 4 x M6		
Non-rotation function	Standard		

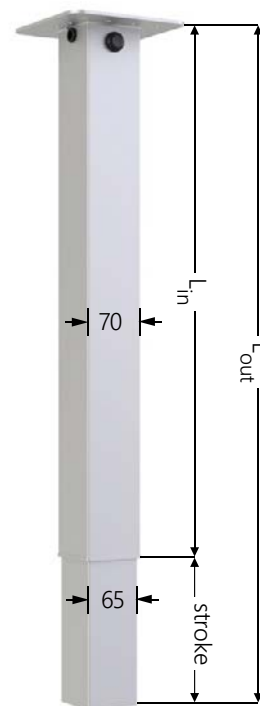

Big Tube Up (BTU)

All dimensions in mm.

Features

- Elegant design with square tubes
- Available in versions BTU - Big Tube Up and BTD - Big Tube Down
- Robust guide system
- Available in two versions of gas springs (rigid and elastic locking)
- Non-rotational column
- Quick and easy to adjust
- Plug & Play assembly

Applications

- Side table
- Speaker's desk
- Trolleys, carts
- Overbed tables



VariStand

Height-adjustable table column (round column)

The VariStand table column is a professional, sophisticated, design-orientated solution for all table and cart applications. It is characterized by its ease of use and plug & play assembly.

VariStand offers high-quality and comfortable height adjustment.

Characteristics	Values			
Order number	13652065	13652067	13652064	13652066
Dimension BTU (Big Tube Up)	Ø 75 mm / Ø 70 mm			
Length when extended (L_{out})	1,040 mm	660 mm	1,040 mm	660 mm
Stroke	415 mm	225 mm	415 mm	225 mm
Length when compressed (L_{in})	625 mm	435 mm	625 mm	435 mm
Stroke force	From 70 N up to 400 N, according to weight of tabletop or application			
Surface finishing	Chromium-plated, powder coated (RAL 9006), further RAL colors on request			
Activation/release	Lever, cable-release			
Tabletop fitting	Flange adapter (with 12 drillholes, distance 32 mm)			
Base fitting	Flange or cone with 3 x M6			
Non-rotation function	Standard			

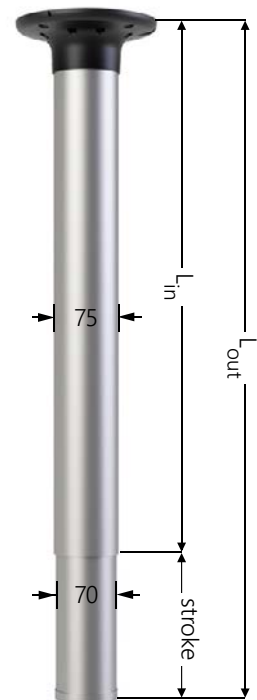

Big Tube Up (BTU)

All dimensions in mm.

Features

- Elegant design with round tubes
- Precise and silent guide system
- Rigid and elastic locking in any position
- Constant remaining adjustment force in any position
- Optimal anti-twist protection
- Large adjustment range with small installation length
- Quick and easy adjustability
- Easy installation due to plug & play
- Override function: lifting without release actuation (optional)
- The lockable gas struts HY6 or EL2 are installed in the guide tube

Applications

- Side table
- Speaker's desk
- Trolleys, carts
- Overbed tables



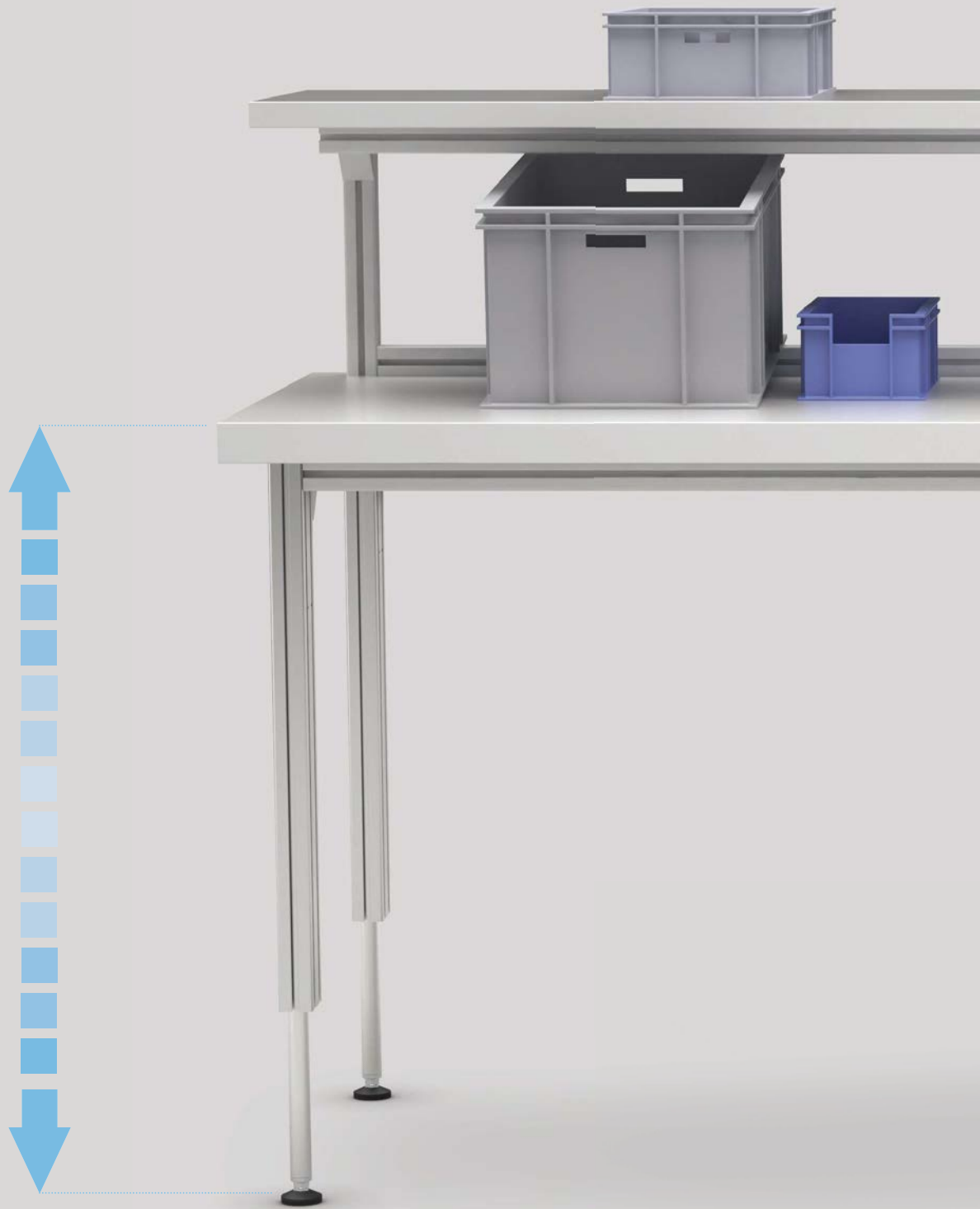

Height Adjustment Industry

Ergonomics at the workplace

Adjust industrial facilities, workbenches, conveyor belts and all types of industrial worktables flexibly to the requirements of your employees and production - and not vice versa. SUSPA height adjustments support you efficiently and individually.

Type	Characteristics	Drive
Movotec SMS Bolt-On	<ul style="list-style-type: none"> • As an upgrade system for existing workplaces • Load performance 150kg/lift element • Adjustable range up to 400 mm 	electric
Assembly profile Movotec SMS	<ul style="list-style-type: none"> • Actuators built in profiles • Load performance 150kg/lift element • Dimension 40x80 mm or 45x90 mm • Adjustable range up to 400 mm 	electric
Lifting Columns ELS3 HeavyDuty	<ul style="list-style-type: none"> • Elegant solution for heavy loads • Load performance 100kg/ lift element • Square guiding tube • Adjustable range up to 500 mm 	electric
Movotec Lift Systems	<ul style="list-style-type: none"> • Drive via hand crank or electric motor • Load performance 150kg/lift element • Adjustable range up to 400 mm 	hydraulic

Applications

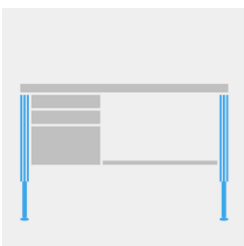

Workbench

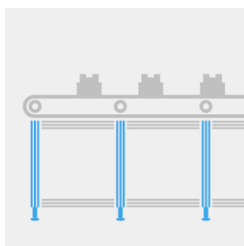

Conveyor belt

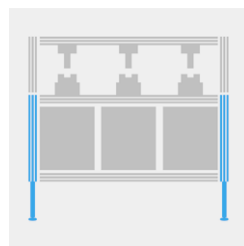

System construction

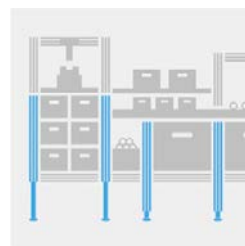

Workplace system



Please find the assembly instruction for all adjustment systems online at www.suspa.com/global/downloads/

Movotec SMS and ELS3 HeavyDuty

Height adjustment for work systems and work benches

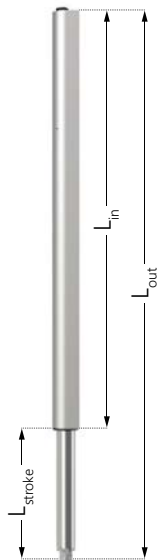
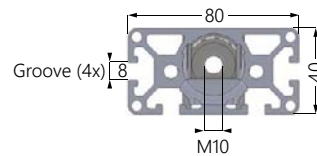
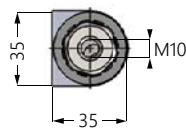

retrofit

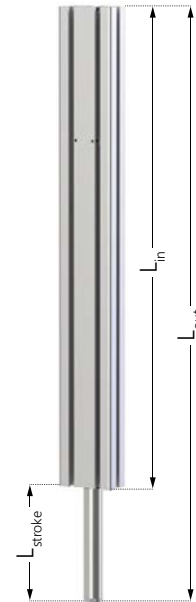

for work systems

	Movotec SMS Bolt-On				Movotec SMS-I-40x80w			
--	---------------------	--	--	--	----------------------	--	--	--

Installation dimensions

Dimensions of external profile/tube	CB profile 35 mm				Installation profile 40x80 mm			
External tube material	Aluminum, silver anodized				Aluminum, silver anodized			
Internal tube dimensions	Ø 25 mm				Ø 25 mm			
Internal tube material	Aluminum, anodized				Aluminum, anodized			
Motor housing dimensions	Motor integrated into profile				Motor integrated into profile			
Order number	00410211	00410212	00410213	00410214	00410268	00410269	00410270	00410271
Stroke (L_{stroke})	150 mm	200 mm	300 mm	400 mm	150 mm	200 mm	300 mm	400 mm
Retracted length (L_{in})	485 mm	535 mm	635 mm	735 mm	510 mm	560 mm	660 mm	760 mm
Extended length (L_{out})	635 mm	735 mm	935 mm	1,135 mm	660 mm	760 mm	960 mm	1,160 mm
Fastening structure	4 x M5 (screw-in depth max. 7 mm)				4 x grooves 8 mm wide			
Fastening on foot stabilizer	1 x M10 (internal thread)				1 x M10 (internal thread)			

Performance data

Max. extension force per lifting element	150 kg / 75 kg				150 kg / 75 kg			
Max. extension force with 4-leg system	600 kg / 300 kg				600 kg / 300 kg			
Max. extension force with 8-leg system	1,200 kg / 600 kg				1,200 kg / 600 kg			
Travel speed	~ 8 mm/s / ~ 16 mm/s				~ 8 mm/s / ~ 16 mm/s			
Functional operating range	+5°C to +40°C				+5°C to +40°C			
Protection class	IP 40				IP 40			

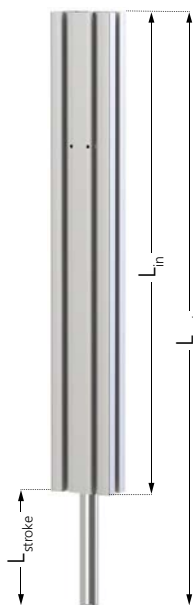
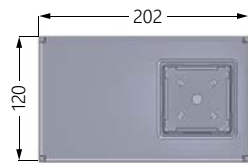
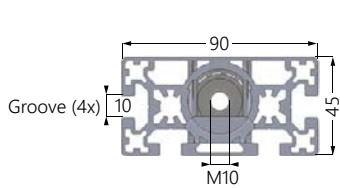

for work systems

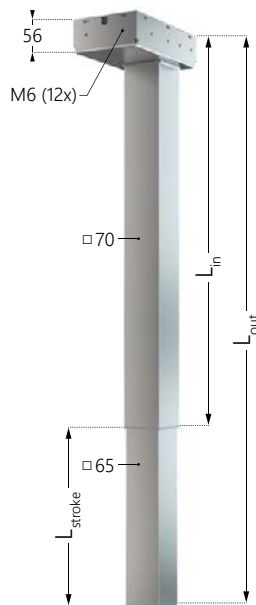

for work benches

All dimensions in mm.

Movotec SMS-B-45x90

ELS3-500S-BTU-Q-HeavyDuty

Installation profile 45x90 mm				70x70 mm
Aluminum, silver anodized				Steel profile, painted silver-gray
Ø 25 mm				65x65 mm
Aluminum, anodized				Steel profile, painted silver-gray
Motor integrated into profile				202x120x56 mm
00410272	00410273	00410274	00410275	00410267
150 mm	200 mm	300 mm	400 mm	500 mm
510 mm	560 mm	660 mm	760 mm	680 mm
660 mm	760 mm	960 mm	1.160 mm	1,180 mm
4xgrooves 10 mm wide				12xM6 (screw-in depth max. 5 mm)
1xM10 (internal thread)				4xM8 (internal thread)
150 kg / 75 kg				100 kg
600 kg / 300 kg				400 kg
1,200 kg / 600 kg				800 kg (on request)
~ 8 mm/s		~ 16 mm/s		~ 20 mm/s
+5°C to +40°C				+5°C to +40°C
IP 40				IP 20

Movotec SMS and ELS3 HeavyDuty Accessories

ELS3 HeavyDuty Subframe

We offer a complete table subframe made of steel profile (silver-gray color RAL 9006) for two or four ELS3 HeavyDuty lifting columns, with screws and adjustable bases (for the lifting column specification, see the table on page 55). The table subframe is suitable for table tops with the dimension 1,600x800 mm, 1,800x800 mm or 2,000x800 mm.



All dimensions in mm.

2-leg HeavyDuty subframe		
Table frame length	Order number	Description
1,600 mm	15311964	EAT3-HD-1600-002-01-S
1,800 mm	15311965	EAT3-HD-1800-002-01-S
2,000 mm	15311966	EAT3-HD-2000-002-01-S

4-leg HeavyDuty subframe		
Table frame length	Order number	Description
1,600 mm	15311967	EAT3-HD-1600-004-01-S
1,800 mm	15311968	EAT3-HD-1800-004-01-S
2,000 mm	15311969	EAT3-HD-2000-004-01-S



Please find the assembly instruction online at www.suspa.com/suspa-downloads/

Control box and link cable for ELS3 HeavyDuty and Movotec SMS

Control box SCT4

- Input voltage: 230V/50Hz
- Output rating: 340 VA (28VDC at 10% switch-on duration)
- Four actuator outlets per control, extendable to eight actuators with link cable
- Load-independent actuator synchronization
- Switch-on duration 10% (2 min operation/ 18 min pause)
- Standby use: < 4W (on request < 0.4W)
- Soft-Start and Soft-Stop
- Travel monitoring to protect the system
- Weight (typical): approx. 3.2 kg (toroidal transformer)
- Dimensions: 257 x 120 x 60 mm
- Protection class II (protective insulation)

Link cable

Order no. 19810134

- Connection of two controllers (for 6- or 8-actuator-systems)
- 4 m cable length



Hand switches for ELS3 HeavyDuty and Movotec SMS

- for installation below the table (cable length: 2 m)



Hand switch Up-Down
UBM F02-p

Order no. 09810087

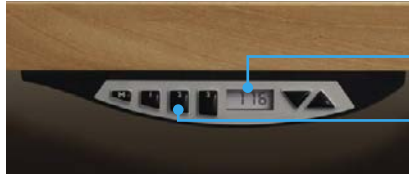

Hand switch memory
UBS/6-s-LCD

Order no. 09810088

Additional digital display
with three programmable
memory positions

Glides and brackets for Movotec SMS



Standard sliding feet

Order no. 07901031



Installation feet

Order no. 07900003



Sliding polyamide feet

Order no. 07901037

- Standard with anti-skid function
- Polyamide base with non-skid TPE pad with M10x1.5-threaded steel bolts with locknut for adjustment
- For fastening the actuators to the floor or to work surfaces
- Aluminum base with M10x1.5-threaded steel bolts with locknut for adjustment
- Standard sliding feet without anti-skid function
- Polyamide base with M10x1.5-threaded steel bolts with locknut for adjustment



Small Mounting
Bracket Set

Order no. 07900002A



Large Mounting
Bracket Set

Order no. 07900001



L Mounting
Bracket Set

Order no. 07900018



Creform®
Bracket Adaptor Set

Order no. 07911027*

- Mounting fasteners can be used if the threaded holes of the SMS CB actuators are not at an optimal place for the application
- One bracket set order for each SMS actuator used

* for easy fastening of
Creform® connectors
(connectors not included)

Movotec Lift Systems

The hydraulic adjustment system for heavy loads

Height adjustment for retrofit

The Bolt-On system is delivered as a kit for retrofitting. Using the retrofit system, you can retrofit your work table that previously could not be adjusted in height with just a few steps, thus making it a height-adjustable workplace. The system includes four to eight Bolt-On cylinders and a pump with hand crank or electric motor.

Movotec Bolt-On Systems

System with hand crank



System with electric motor



max. load (kg)	Adjusting range/stroke* (mm)			
340	150	200	300	400
454	150	200	300	400
590	150	230	300	393

* The adjusting range of systems with electric motor is 6-8mm less.

The system includes

- Crank or motor driven system (incl. control box and switches)
- 1 to 4 Bolt-On lift cylinders
- Hydraulic flexible tubing in individual lengths
- Glides for each lift cylinder
- Drilling templates, tubing clips and cable ties
- Installation and operating instructions

Movotec "Bolt-On" lift systems are readily available, shipped completely assembled and ready for installation.

Movotec Bolt-On Dual Drive Systems for 6 to 8 cylinders

Synchronized 8-leg-system with electric motor



max. load (kg)	Adjusting range / stroke* (mm)				Number of cylinders
680	150	200	300	400	6
907	150	200	300	400	8

* The adjusting range of systems with electric motor is 6-8mm less.

The system includes

- Two synchronized motor driven systems with controllers and switch
- 5 to 8 Bolt-On lift cylinders
- Hydraulic flexible tubing in individual lengths
- Glides for each lift cylinder
- Drilling templates, tubing clips and cable ties
- Installation and operating instructions

Movotec Dual Drive Lift Systems are shipped assembled and ready for installation.

 Please find pumps, components and accessories in our Movotec catalog under www.suspa.com/downloads/SUSPA_Movotec_DE.pdf



Pump with handcrank



Caster



Foot switch



SUSPA – Your strong industrial partner

For more than 60 years, SUSPA products have been present in your daily life - at home in furniture, refrigerators and washing machines, in means of transport like buses, trains and planes, in modern office furniture, in leisure and fitness equipment, but also in hospitals and rehab centers.

Although you may not be able to see our products, we are always there – increasing the comfort and safety level for all of you.

Major players in the automobile, office furniture, industrial, transportation, appliance, health care, leisure, and gaming industries depend on SUSPA as a developmental and systems solution partner. Our engineers and technical sales team will work seamlessly with your staff on a wide variety of projects, committed to providing the most effective solution for your organization.

Reliability as the highest standard

Requirements on quality are increasing in the automotive industry as well as in other industry sectors. SUSPA certifications according to IATF 16949 have therefore been an integral part.

Effective quality management from purchasing to production and sales and on to final application secures the worldwide great reputation and reliability of SUSPA products.

SUSPA moves.

With more than 2,000 employees worldwide SUSPA manufactures gas springs, dampers, adjustment systems as well as crash and safety systems for many sectors; from furniture through to automobile industry.

SUSPA GmbH

Industriestr. 12-14
90518 Altdorf
Germany

Phone +49 9187 930 355
Fax +49 9187 930 311

infoindustry@de.suspa.com
www.suspa.com

www.suspa.com