

## Bolțuri de poziționare • cu bilă la capăt

22630.0608



### Descrierea produsului

Bolțul cu bilă la capăt facilitează introducerea pieselor de lucru și evită înclinarea fixării.

### Material

- Oțel pentru scule, călit, șlefuit și brunat

### Desen



Figura 1



Figura 2

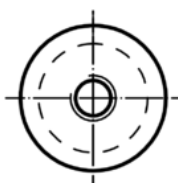
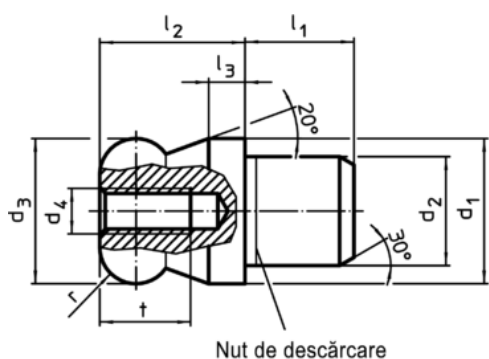

Figura 3



Figura 4

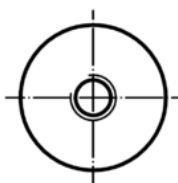
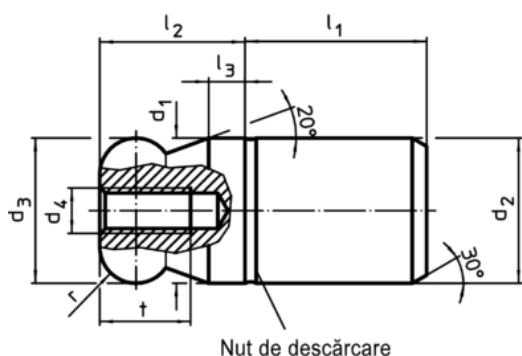
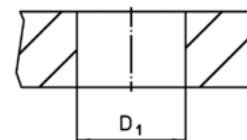

### Informații comandă

Dimensiuni										Poziție orificiu	RoHS	REACH	Ref. Nr.	
d <sub>1</sub>	d <sub>2</sub>	d <sub>3</sub>	d <sub>4</sub>	l <sub>1</sub>	l <sub>2</sub>	l <sub>3</sub>	t	r	b	D <sub>1</sub>				
g6	n6	-0,01 -0,05								H7				
[mm]										[mm]	[g]			
cu bilă la capăt, teșită, – figura 4, Oțel pentru scule														
8	8	8	M3	10	8	2	6	2	1,9	8	5	Reclamație- RoHS	nu conține materiale SVHC	22630.0608

Exemplu de aplicație

