

Bolțuri de poziționare • cu bilă la capăt

22630.0616



Descrierea produsului

Bolțul cu bilă la capăt facilitează introducerea pieselor de lucru și evită înclinarea fixării.

Material

- Oțel pentru scule, călit, șlefuit și brunat

Desen



Figura 1



Figura 2

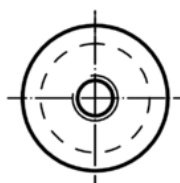
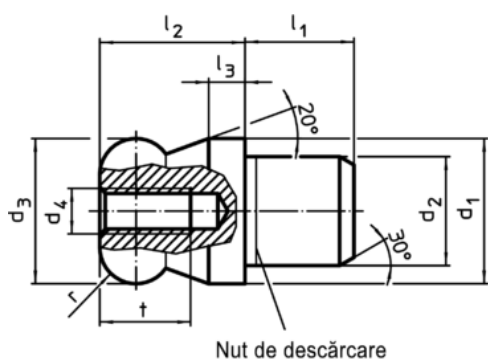

Figura 3



Figura 4

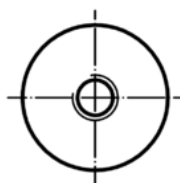
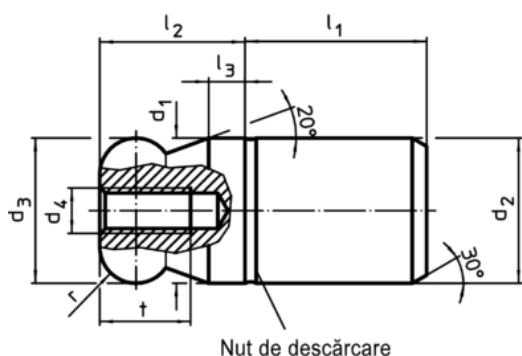
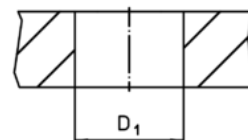

Informații comandă

Dimensiuni										Poziție orificiu	RoHS	REACH	Ref. Nr.	
d ₁	d ₂	d ₃	d ₄	l ₁	l ₂	l ₃	t	r	b	D ₁				
g6	n6	-0,01 -0,05								H7				
[mm]										[mm]	[g]			
cu bilă la capăt, teșită, – figura 4, Oțel pentru scule														
16	16	16	M5	20	16	4	10	4	4,3	16	44	Reclamație- RoHS	nu conține materiale SVHC	22630.0616

Exemplu de aplicație

