

Bridă • cu cioc
23180.0217

Descrierea produsului

This clamp (clamping claw) with nose is mainly used in mechanical clamping technology for clamping workpieces.

Material

- Oțel tratat termic, cu revenire, brunat



Desen



Figura 1



Figura 2

Informații comandă

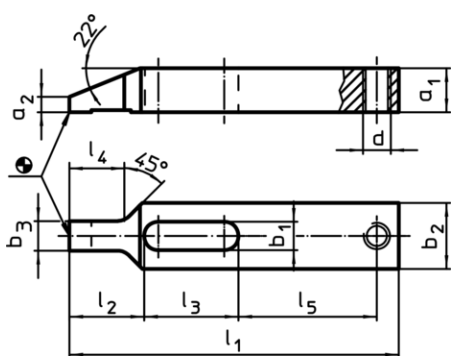
Mărime nominală b ₁ [mm]	Dimensiuni										[g]	RoHS	REACH	Ref. Nr.
	l ₁	a ₁	a ₂	a ₃	b ₂	b ₃	l ₂	l ₃	l ₄					
cu nut – figura 2														
17	175	25	9	4,5	35	15,5	40	52	29	812	Reclamație- RoHS	nu conține materiale SVHC	23180.0217	

Exemplu de aplicație

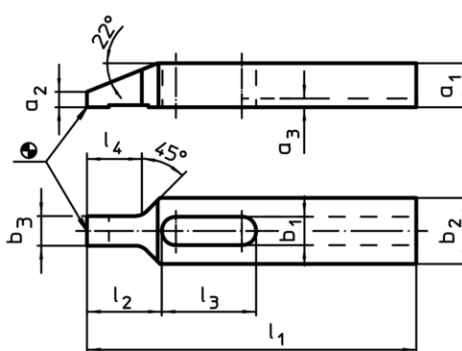