

Bridă • cu cioc, închis

23170.0027

Descrierea produsului

This clamp (clamping claw) according to DIN 6317 with nose is mainly used in mechanical clamping technology for clamping workpieces. Due to the closed design of the clamp, it is suitable for use with rotating workpieces.

Datorită canalului închis, această bridă se pretează la aplicații rotative.



Material

- Oțel tratat termic, lăcuit

Desen

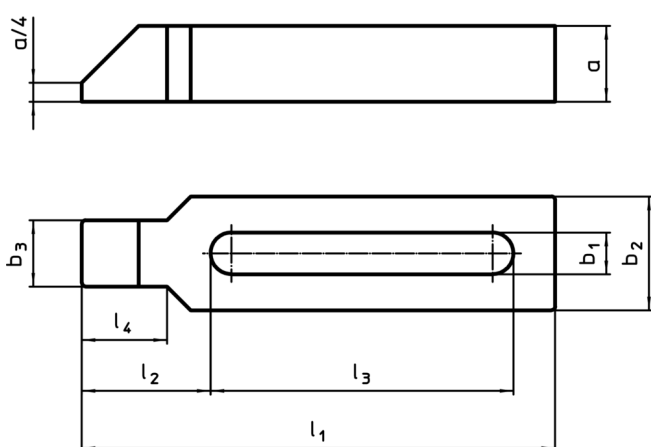

Informații comandă

Mărime nominală b ₁ [mm]	Dimensiuni							Pentru șuruburi		[g]	RoHS	REACH	Ref. Nr.
	l ₁	a	b ₂	b ₃	l ₂	l ₃	l ₄	[mm]	[inch]				
26	315	40	70	43	83	200	56	M24	1	4560	Reclamație- RoHS	nu conține materiale SVHC	23170.0027

Exemplu de aplicație

