

Bridă • DIN 6314 plat

23140.0015

Descrierea produsului

This clamp (clamping claw) according to DIN 6314 is mainly used in mechanical clamping technology for clamping workpieces.

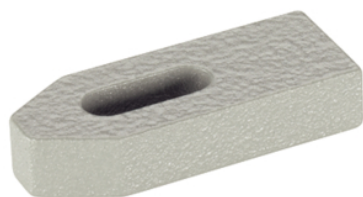

Material

- Oțel tratat termic, lăcuit

Desen

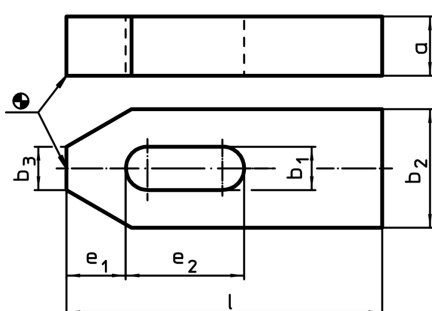

Informații comandă

Mărime nominală b ₁ [mm]	l	Dimensiuni					Pentru șuruburi		RoHS	REACH	Ref. Nr.
		a	b ₂	b ₃	e ₁	e ₂	[mm]	[inch]			
14	125	20	40	14	21	50	M12, M14	1/2	623	Reclamație- RoHS nu conține materiale SVHC	23140.0015

Exemplu de aplicație

