

Bridă • DIN 6314 plat

23140.0023

Descrierea produsului

This clamp (clamping claw) according to DIN 6314 is mainly used in mechanical clamping technology for clamping workpieces.

Material

- Oțel tratat termic, lăcuit

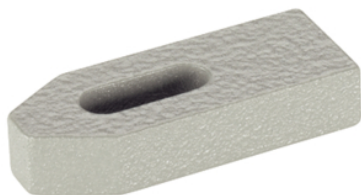

Desen

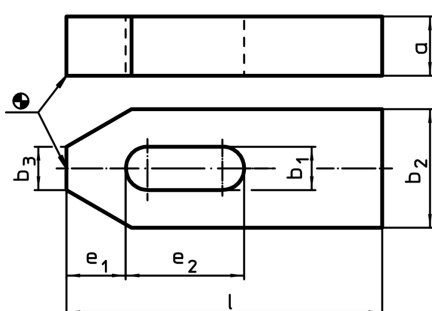

Informații comandă

Mărime nominală b ₁ [mm]	l	Dimensiuni					Pentru șuruburi		[g]	RoHS	REACH	Ref. Nr.
		a	b ₂	b ₃	e ₁	e ₂	[mm]	[inch]				
22	200	30	60	22	30	80	M20, M22	3/4	2244	Reclamație- RoHS	nu conține materiale SVHC	23140.0023

Exemplu de aplicație

