

## Elemente bridă actima

23260.0015



### Descrierea produsului

Element de prindere compact pentru tragere și împingere cu ajutorul căruia se poate transforma tensiunea de prindere prin rotirea manșonului de presiune. Cursa este de 10 mm. În cazul cursei scurte de 2 mm, autoblocarea apare în orice poziție. Forța maximă de prindere permisă este de 4,9 kN.

### Material

#### Carcasă

- Termoplastic, negru

#### Corp

- Oțel, brunat

#### Maner sferic

- DIN 7708 - termoplastic (PF 31) , roșu  
similar cu RAL 3003

#### Accesorii

- Oțel, brunat

Desen

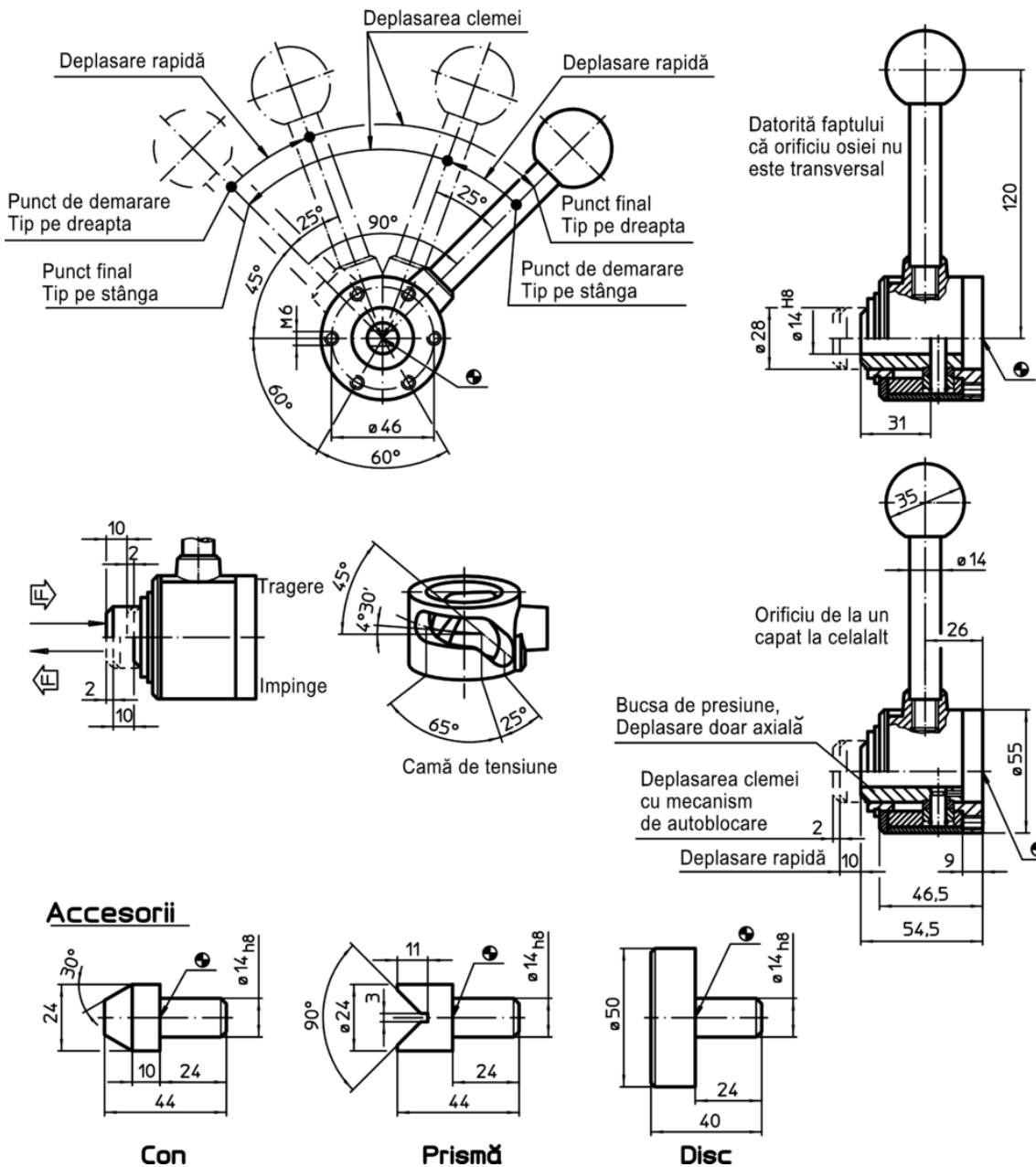

Accesorii

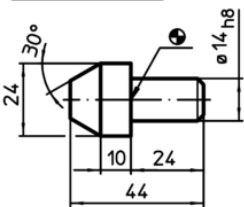

Con

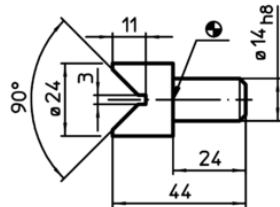

Prismă

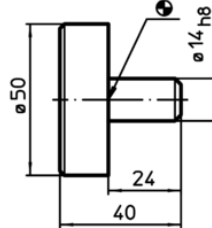





Disc

Informații comandă

Calea de deplasare [mm]	s Distanța prindere [mm]	Forța de strângere max. [kN]	[g]	RoHS	REACH	Ref. Nr.
trage spre stânga, cu gaură de trecere						
10	2	4,9	750	Reclamație- RoHS	conține materiale SVHC >0.1% w/w	23260.0015

Accesorii

	 [g]	RoHS	REACH	Ref. Nr.
<b>disc</b>				
	270	Reclama#ie- RoHS	con#ine materiale SVHC >0.1% w/w	23260.0042
<b>con</b>				
	85	Reclama#ie- RoHS	con#ine materiale SVHC >0.1% w/w	23260.0044
<b>prismă</b>				
	82	Reclama#ie- RoHS	con#ine materiale SVHC >0.1% w/w	23260.0046

Exemplu de aplicație

