

Elemente bridă actima

23260.0004



Descrierea produsului

Element de prindere compact pentru tragere și împingere cu ajutorul căruia se poate transforma tensiunea de prindere prin rotirea manșonului de presiune. Cursa este de 10 mm. În cazul cursei scurte de 2 mm, autoblocarea apare în orice poziție. Forța maximă de prindere permisă este de 4,9 kN.

Material

Carcasă

- Termoplastic, negru

Corp

- Oțel, brunat

Maner sferic

- DIN 7708 - termoplastic (PF 31) , roșu
similar cu RAL 3003

Accesorii

- Oțel, brunat

Desen

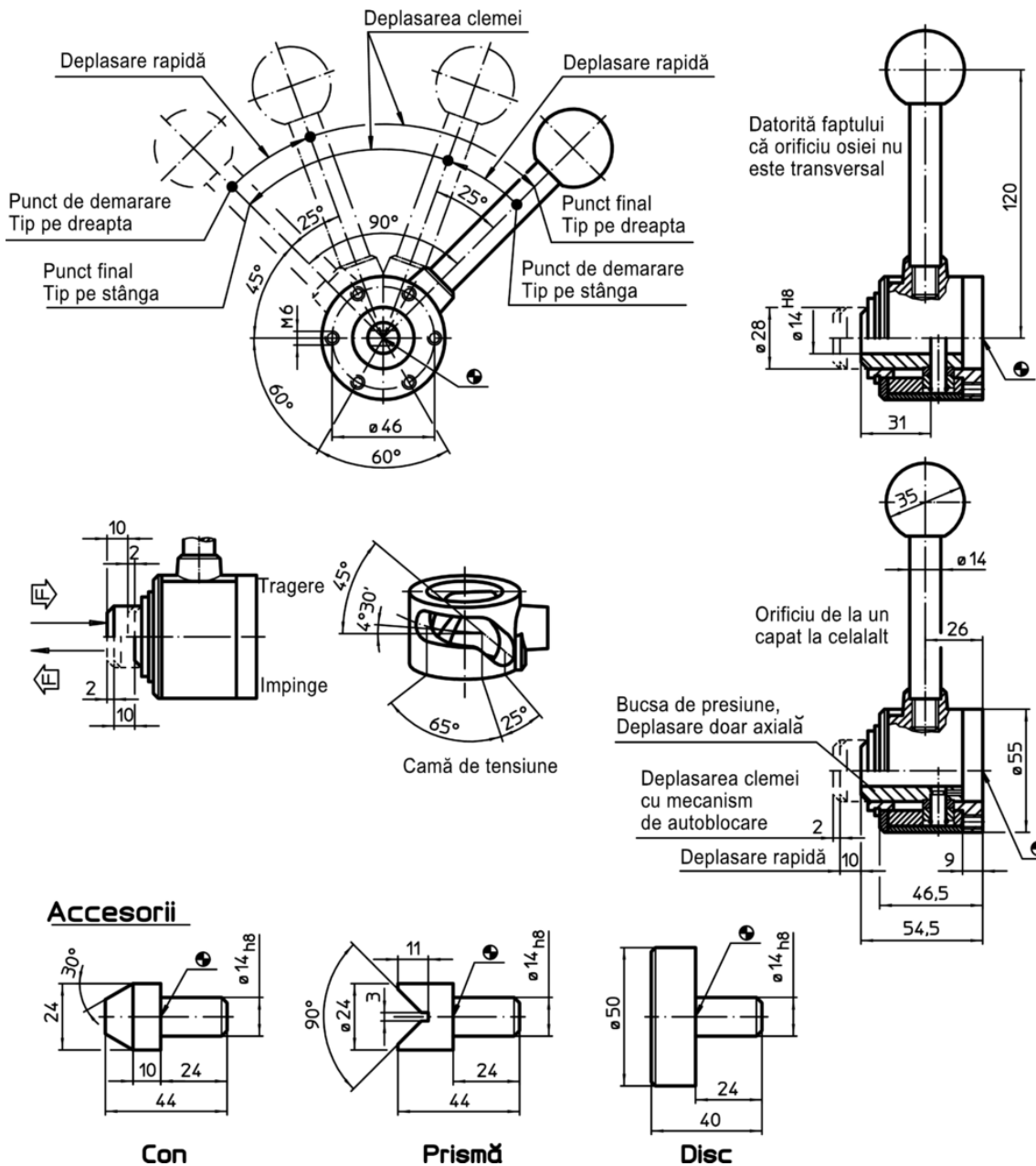

Accesorii

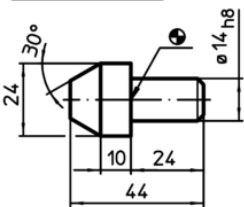

Con

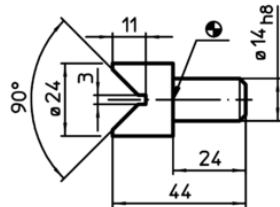

Prismă

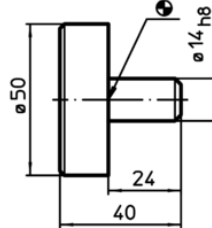





Disc

Informații comandă

Calea de deplasare [mm]	s Distanța prindere [mm]	Forța de strângere max. [kN]	[g]	RoHS	REACH	Ref. Nr.
împinge spre stânga, cuaxat transversal în alezaj						
10	2	4,9	749	Reclamație- RoHS	conține materiale SVHC >0.1% w/w	23260.0004

Accesorii

	 [g]	RoHS	REACH	Ref. Nr.
disc				
	270	Reclama#ie- RoHS	con#ine materiale SVHC >0.1% w/w	23260.0042
con				
	85	Reclama#ie- RoHS	con#ine materiale SVHC >0.1% w/w	23260.0044
prismă				
	82	Reclama#ie- RoHS	con#ine materiale SVHC >0.1% w/w	23260.0046

Exemplu de aplicație

