

## Three-lobed Torque Handles

24711.0516



### Descrierea produsului

#### Material

**Capac**  
• Plastic, gri deschis

**Mecanism de cuplu**  
• Oțel, călit

**Element intern**  
• Oțel, brunat

**Șurub**  
• Oțel, brunat

#### Mai multe informații

#### Produse asociate

• Mâner de tracțiune

### Desen



Figura 1

Figura 2

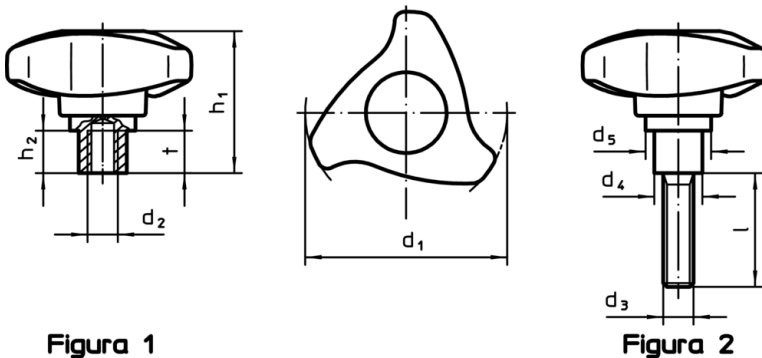
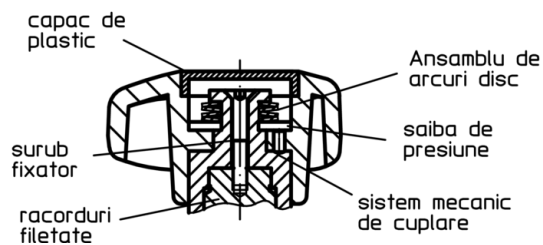

### Informații comandă

Dimensiuni		l	Moment strângere +/- 10% max. [Nm]		[g]	RoHS	REACH	Ref. Nr.
d <sub>1</sub>	d <sub>3</sub>		d <sub>4</sub>	d <sub>5</sub>				
cu șurub – figura 2								
80	M12	25	19	34,1	56,2	16,8	5,5	202
						Reclamație- RoHS	conține materiale SVHC >0.1% w/w	24711.0516

Exemplu de aplicație

