

Three-lobed Torque Handles

24711.0520



Descrierea produsului

Material

Capac
• Plastic, gri deschis

Mecanism de cuplu
• Oțel, călit

Element intern
• Oțel, brunat

Șurub
• Oțel, brunat

Mai multe informații

Produse asociate

• Mâner de tracțiune

Desen



Figura 1

Figura 2

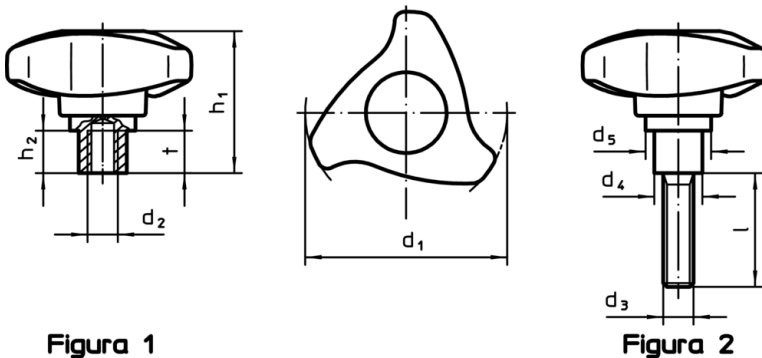
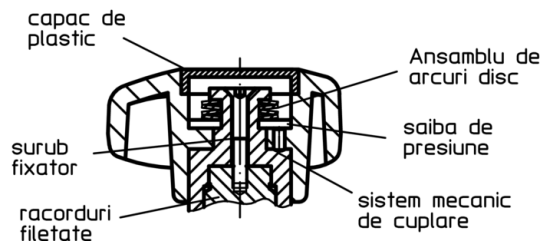

Informații comandă

Dimensiuni							Moment strângere +/- 10% max. [Nm]	[g]	RoHS	REACH	Ref. Nr.
d ₁	d ₃	l	d ₄	d ₅	h ₁	h ₂					
[mm]											
cu șurub – figura 2											
80	M12	32	19	34,1	56,2	16,8	7,5	207	Reclamație- RoHS	conține materiale SVHC >0.1% w/w	24711.0520

Exemplu de aplicație

