

Mânere palmiforme • DIN 6335 oțel inoxidabil turnat  
24631.0440



Descrierea produsului

Material

Mâner

- Oțel inoxidabil A2, mat sablat

Desen

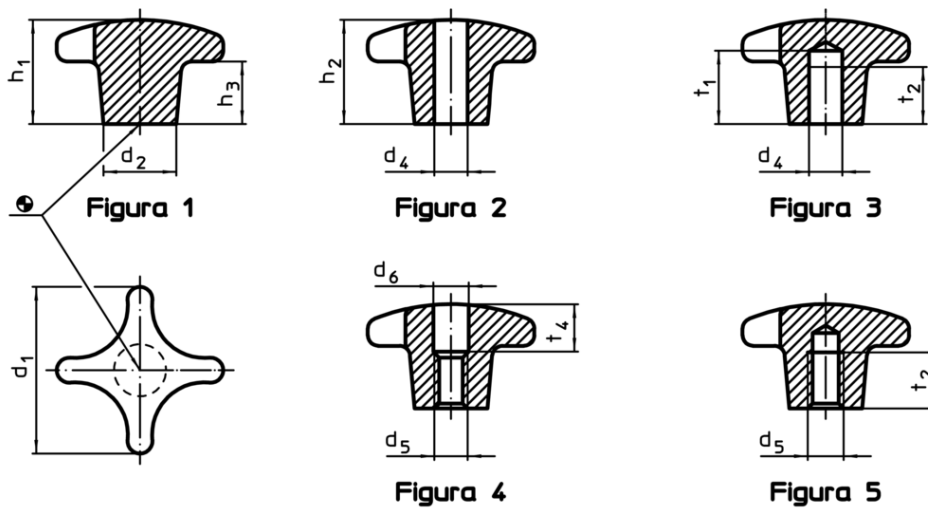

Informații comandă

d <sub>1</sub>	d <sub>2</sub>	Dimensiuni d <sub>5</sub> [mm]	h <sub>2</sub>	t <sub>2</sub>	 [g]	RoHS	REACH	Ref. Nr.
cu gaură înfundată filetată, forma E – figura 5								
40	14	M8	25	15	62	Reclamație- RoHS	nu conține materiale SVHC	24631.0440

Exemplu de aplicație

