

Șuruburi pt. mâner stea • plastic

24750.0121



Descrierea produsului

Material

Capac

- Termoplastice PA, alb similar RAL 9019

Mâner

- Termoplastice PA 6, negru similar RAL 9005

Șurub

- oțel inoxidabil

Mai multe informații

Note

Variante speciale, de ex. diferite filete sau diferite lungimi ale filetelor sunt posibile la cerere.

Desen

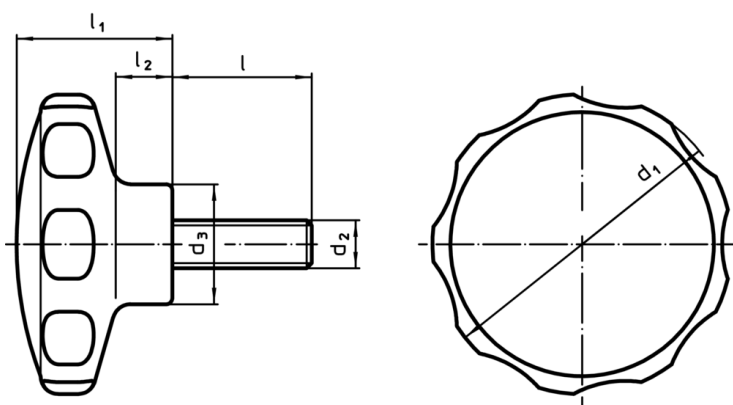

Informații comandă

Dimensiuni							min.	max.	[g]	RoHS	REACH	Ref. Nr.
d ₁	d ₂	l	d ₃	l ₁	l ₂	[mm]						
alb												
30	M4	18	14	19	7		-30	80	6,9	Reclamație- RoHS	nu conține materiale SVHC	24750.0121

Exemplu de aplicație

