

Șuruburi pt. mâner stea • plastic

24750.0304



Descrierea produsului

Material

Capac

- Termoplastice PA, albastru similar RAL 5015

Mâner

- Termoplastice PA 6, negru similar RAL 9005

Șurub

- oțel inoxidabil

Mai multe informații

Note

Variante speciale, de ex. diferite filete sau diferite lungimi ale filetelor sunt posibile la cerere.

Desen

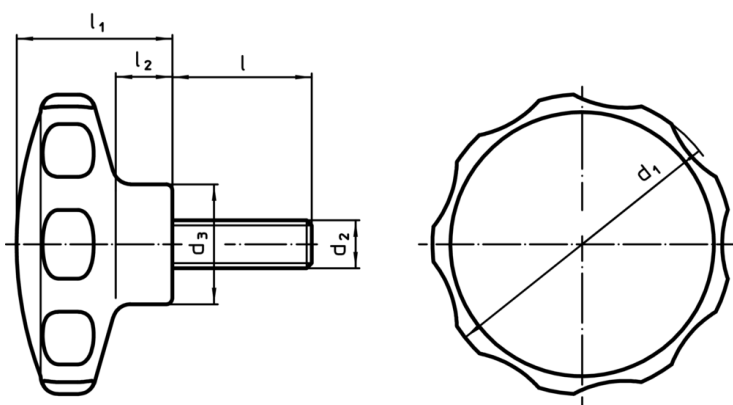

Informații comandă

Dimensiuni						min.	max.	[g]	RoHS	REACH	Ref. Nr.
d ₁	d ₂	l	d ₃	l ₁	l ₂						
albastru											
50	M6	14	22	26	10	-30	80	19	Reclamație- RoHS	nu conține materiale SVHC	24750.0304

Exemplu de aplicație

