

Mâner deget
24520.0126



Descrierea produsului

Material

- Oțel inoxidabil 1.4305, sablare mată

Desen



Figura 1



Figura 2

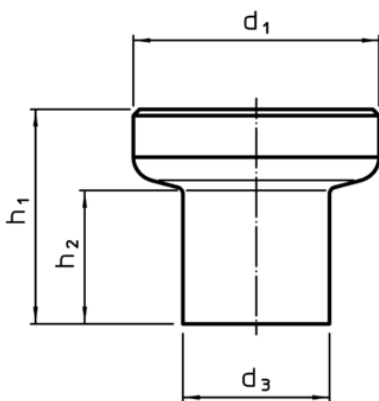

Informații comandă

Dimensiuni							[g]	RoHS	REACH	Ref. Nr.
d ₁	d ₂	d ₃	h ₁	h ₂	t min.					
cu striații – figura 2, oțel inoxidabil										
25	M8	14,5	22,5	14	12	40	Reclamație- RoHS	nu conține materiale SVHC	24520.0126	

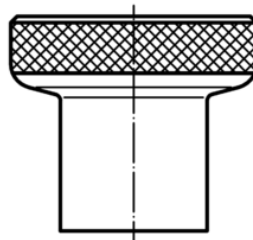
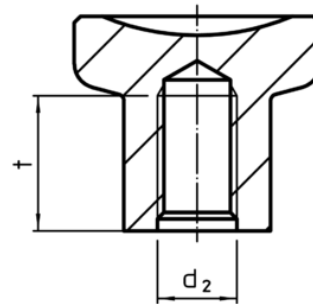
Exemplu de aplicație

