

## Șuruburi moletate • plastic

24830.0042

### Descrierea produsului



#### Material

##### Mâner

- Termoplastic PA, negru

##### Șurub

- Oțel, zincat prin galvanizare

### Desen

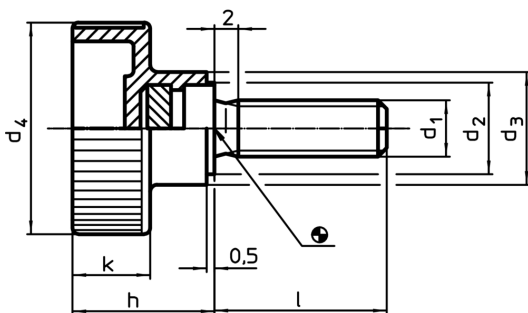

### Informații comandă

Dimensiuni							min.	max.	[g]	RoHS	REACH	Ref. Nr.
d <sub>1</sub>	l	d <sub>2</sub>	d <sub>3</sub>	d <sub>4</sub>	h	k						
oțel												
M5	10	9	12	19	14	8	-30	80	4,3	Reclamație- RoHS	conține materiale SVHC >0.1% w/w	24830.0042

### Exemplu de aplicație

