

Șuruburi moletate • plastic

24830.0250

Descrierea produsului



Material

Mâner

- Termoplastice PA, negru

Șurub

- Oțel inoxidabil 1.4567

Desen

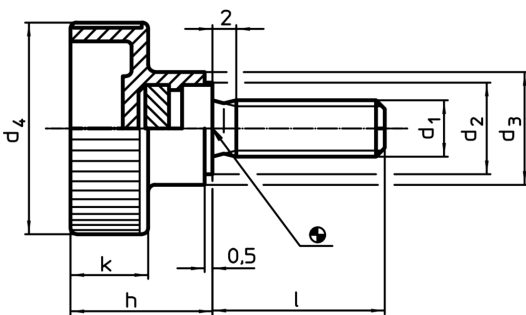

Informații comandă

Dimensiuni							Temperatură		Greutate [g]	RoHS	REACH	Ref. Nr.
d ₁	l	d ₂	d ₃	d ₄	h	k	min.	max.				
[mm]							[°C]					
oțel inoxidabil												
M6	10	12	14	24	16,5	9,5	-30	80	7	Reclamație- RoHS	nu conține materiale SVHC	24830.0250

Exemplu de aplicație

