

Piulițe de strângere • sudate, ambele părți

24470.0712

Descrierea produsului

Permite manipularea cu ambele mâini.

Material

- Oțel, zincat prin galvanizare



Desen

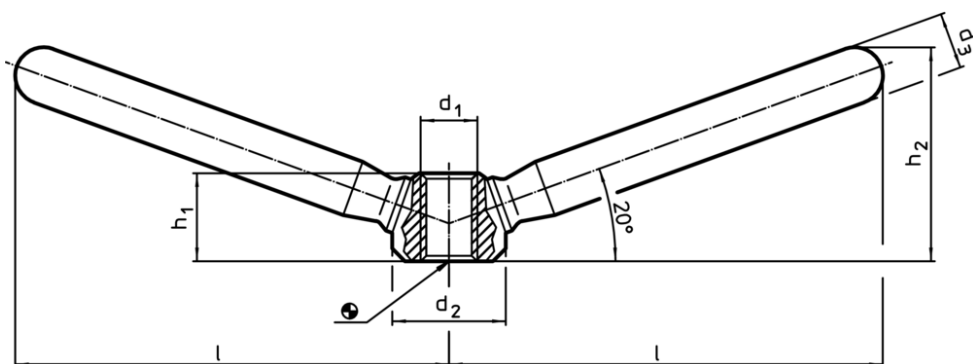

Informații comandă

l	d ₁	Dimensiuni			h ₁	h ₂	[g]	RoHS	REACH	Ref. Nr.
		d ₂	d ₃	[mm]						
94,5	M16	32	18	25	52	432	Reclamație-RoHS	conține materiale SVHC >0.1% w/w	24470.0712	

Exemplu de aplicație

