

## Mâner de strângere

24430.0038



### Descrierea produsului

#### Material

##### Maneta

- Oțel, brunat

##### Maner sferic

- Duroplastic PF 31, negru, DIN 319

### Desen



Figura 1

Figura 2

### Informații comandă

d <sub>1</sub>	d <sub>2</sub>	d <sub>4</sub>	Dimensiuni				[g]	RoHS	REACH	Ref. Nr.
			d <sub>5</sub>	h	l	t <sub>1</sub>				
cu filet interior – figura 1, oțel										
25	M12	10	25	42	95	18	165	Reclamație- RoHS	conține materiale SVHC >0.1% w/w	24430.0038

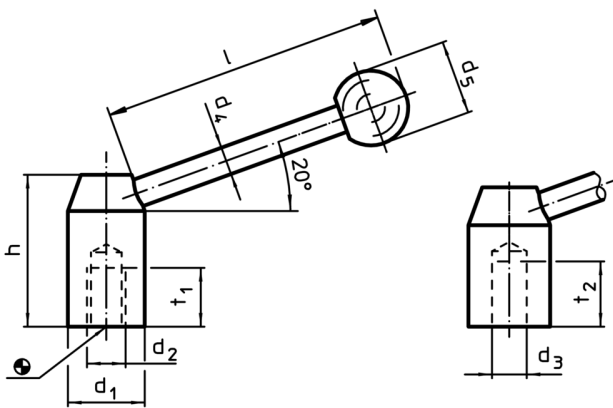
Exemplu de aplicație

