

Mâner de strângere

24430.0058



Descrierea produsului

Material

Maneta

- Oțel, brunat

Maner sferic

- Duroplastic PF 31, negru, DIN 319

Desen



Figura 1

Figura 2

Informații comandă

d ₁	d ₂	d ₄	Dimensiuni				t ₁	[g]	RoHS	REACH	Ref. Nr.
			d ₅	h	l	[mm]					
cu filet interior – figura 1, oțel											
40	M20	16	40	64	154	27	708	Reclamație- RoHS	conține materiale SVHC >0.1% w/w	24430.0058	

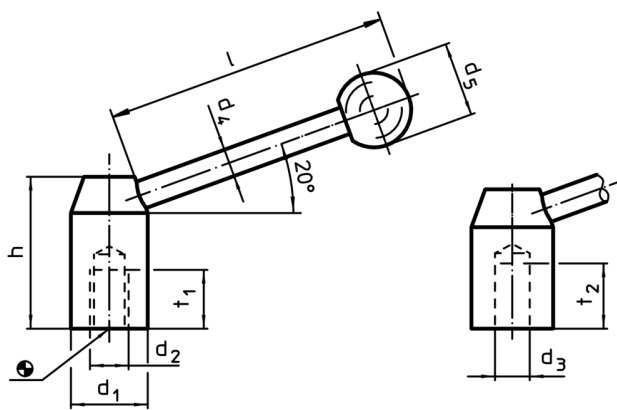
Exemplu de aplicație

