

Mâner de strângere

24430.0055



Descrierea produsului

Material

Maneta

- Oțel, brunat

Maner sferic

- Duroplastic PF 31, negru, DIN 319

Desen





Figura 1

Figura 2

Informații comandă

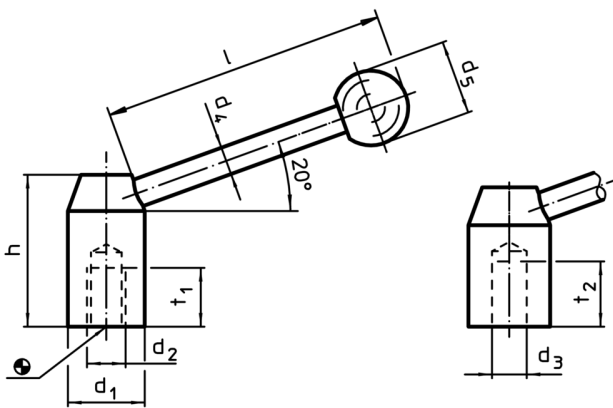
d ₁	d ₃ H7	d ₄	Dimensiuni					RoHS	REACH	Ref. Nr.
			d ₅	h	l	t ₂	[g]			
			[mm]		~					
cu gaură netedă – figura 2, oțel										
40	20	16	40	64	154	30	706	Reclamație- RoHS	conține materiale SVHC >0.1% w/w	24430.0055

Exemplu de aplicație

