

M12-A-5

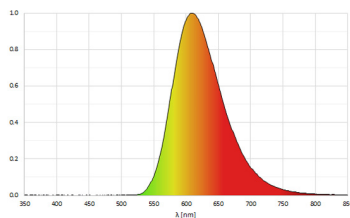
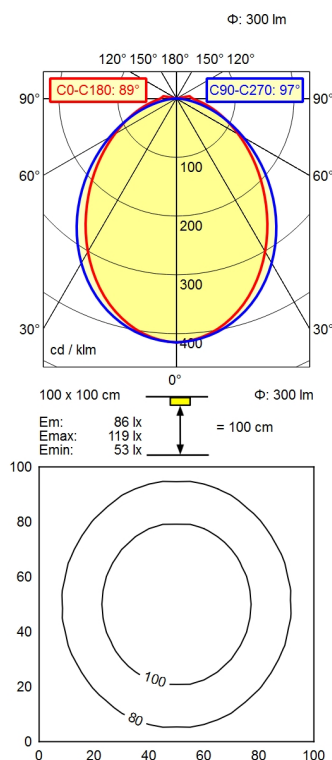

Light source	LED
Work equipment	Without
Connected load	22 - 26 V; DC
Power consumption	ca. 6 W
Luminous flux	approx. 300 lm
Luminous efficiency	approx. 50 lm/W
Light type/color	yellow; Yellow
Light distribution	Direct
Beam angle	89° / 97°
Glare control	Screen
System of protection	IP 54
Class of protection	III
Technology	Switchable; -
Operation	External
Housing	Aluminium/plastic; Anodised, painted; Aluminium coloured anodised Acrylic (PMMA); Satine
Light source cover	
Weight (net)	ca. 0,2 kg
Mains lead	Built-in plug; M12-A-5
Design	mounted version
Fastening	Bracket
Dimension	A=335mm,Cmin=290mm,Cmax=320mm
Minimum ambient temperature	5 °C
Maximum ambient temperature	40 °C
Decorative contrast side parts	Natural silver anodised