

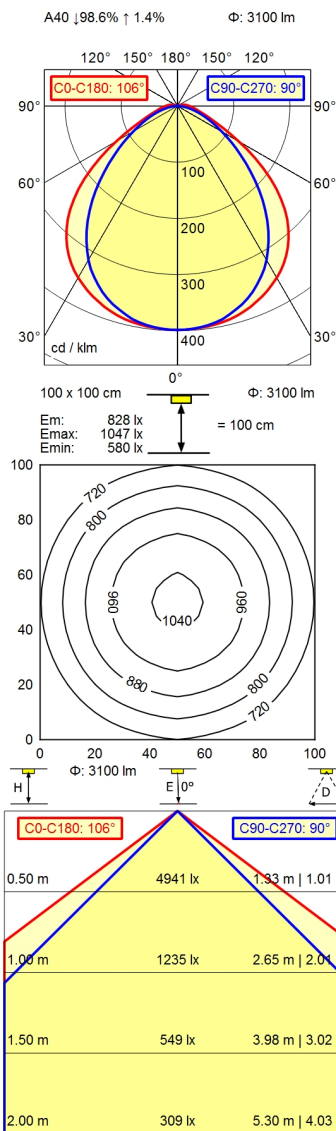

series 272



Light source	LED
Work equipment	Without
Connected load	230 V; AC; 50 Hz; 60 Hz
Power consumption	ca. 40 W
Luminous flux	approx. 3.100 lm
Luminous efficiency ¹⁾	approx. 77 lm/W
Light type/-color	Cold white
Colour temperatur	approx. 5.000 K
Color rendering index	CRI ≥ 80
Light distribution	Direct; approx. 99 %
Beam angle	100°
Chromaticity tolerance LED	< 4 SDCM
Glare control	Diffusor
Luminance (L65)	≤ 17.000 cd/m ²
UGR class (4H 8H; EN 12464-1)	≤ 25
System of protection/Class	IP 67; I
Technology	Switchable
Operation	External
Housing	Acrylic (PMMA), clear
Light source cover	Acrylic (PMMA)
Mains lead	Connector; series 272
Fastening	Pipe clamp (accessory)
Light output	D=736 mm
Side part	A with screwed cable gland
Maximum ambient temperature	40 °C
EAN	4013330107499
Weight without/incl. packaging	ca. 2,1 kg; 2,5 kg
Dimensions (dimensional drawing)	A=790 mm
Packaging dimensions	ca. 1.030 mm; 100 mm; 95 mm
Special features	Light forming

¹⁾ For luminaires with separate control gear, the luminous efficacy refers to the luminaire head without control gear.